



Devices thru Material Innovation

NEC/TOKIN

Vol.05

Ferrite Cores

Ferrite Cores

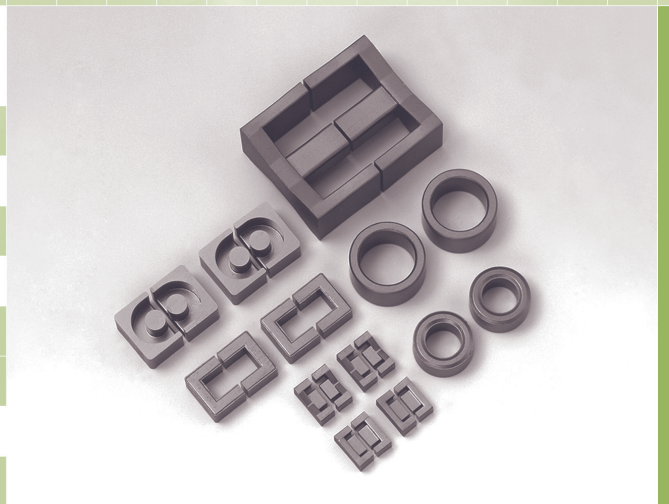

- All specifications in this catalog and production status of products are subject to change without notice. Prior to the purchase, please contact NEC TOKIN for updated product data.
- Please request for a specification sheet for detailed product data prior to the purchase.
- Before using the product in this catalog, please read "Precautions" and other safety precautions listed in the printed version catalog.

CONTENTS

INTRODUCTION	3
Precautions Before Use	4
Notes on Design	4
Notes of Caution on Handling and Usage	5
Terms and Definitions	6
High-B Compound Standard Material Characteristics	9
High- μ Compound Standard Material Characteristics	12
E Type Ferrite Cores	13
FEI-Type Cores	14
FEE-Type Cores	15
E-Type Bobbins	17
FEER Type Ferrite Cores	18
FEER-Type Cores	19
FEER-Type Bobbins	20
FPQ Type Ferrite Cores	21
FPQ-Type Cores	22
FPQ-Type Bobbins	23
FQK Type Ferrite Cores	24
FQK-Type Cores	25
FQK-Type Bobbins	26
FEP Type Ferrite Cores	27
FEP-Type Cores	27
P Type Ferrite Cores	28
P-Type Cores	28
RM Type Ferrite Cores	29
RM-Type Cores	29
FUU Type Ferrite Cores	30
FUU-Type Cores	30
Toroidal Cores	31
BH2 Compound Technical Data	33



- All specifications in this catalog and production status of products are subject to change without notice. Prior to the purchase, please contact NEC TOKIN for updated product data.
- Please request for a specification sheet for detailed product data prior to the purchase.
- Before using the product in this catalog, please read "Precautions" and other safety precautions listed in the printed version catalog.

INTRODUCTION

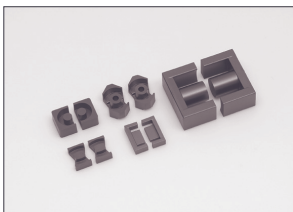

Because soft ferrite, such as MOFe_2O_3 (M:bivalent metal), in the high-frequency range has high magnetic permeability, a large degree of saturation magnetic flux and large characteristic resistance compared to metallic magnetic materials, it is extremely popular as a high-frequency compound.

As switching power supplies rapidly become more compact and thinner, requirements for ferrite as a high-frequency transformer material are becoming increasingly stringent.

To meet these demands, NEC TOKIN has enhanced its lineup of ferrite cores by adding the BH1 and BH2 types (-300 kHz) which feature improved core loss over the B25 type (-300 kHz), and B40 (500 kHz -1 MHz) with improved core loss in high frequencies.

Further, the requirements of larger power supply capacities, increasing thinness and high density mounting are met by the E,FPQ, FEP, FEER and FQK Series, as well as the surface-mounting FEY Series.

●E type cores

This series features 46 shapes and sizes from FE1 12.5 to FEE60W, standard-equipped with accessories for accommodating different transformer specifications.

●FPQ type cores

This series features eight shapes and sizes suitable for high density mounting.

●FEER type cores

This series features 19 shapes and sizes with greater winding cross-sectional area than the E and FPQ types.

●FEY type cores

This series features three shapes and sizes suitable for ultra high-density mounting.



- All specifications in this catalog and production status of products are subject to change without notice. Prior to the purchase, please contact NEC TOKIN for updated product data.
- Please request for a specification sheet for detailed product data prior to the purchase.
- Before using the product in this catalog, please read "Precautions" and other safety precautions listed in the printed version catalog.

Precautions Before Use

Notes on Design

1) When selecting the material and shape for the ferrite core, strictly observe the limits given in the catalog (product manual) regarding such things as the L value, maximum saturation, magnetic flux density, and core loss.

2) Select a ferrite core having temperature and frequency properties for the core loss that meet the demands of the equipment to be used.

3) Abnormal heat release may result if used under high frequencies or in strong magnetic fields. Select a ferrite core that has the appropriate properties such as a low core loss.

4) In an environment where the Curie point is exceeded, the ferrite core may lose its intrinsic properties, causing the equipment to malfunction. Use only in a temperature range that stays below the Curie point.

5) Give careful consideration to the balance of the ferrite core's thickness when designing a shape.

6) When designing a bobbin, set measurements and select bobbin materials that meet the requirements (frame class, thickness, HWI, HAI, HVTR, CTI, and D495) of safety standards such as UL.

7) Working on the coil could destroy the ferrite core owing to the coil's thickness or damage the coil itself, so designs should provide adequate clearance between the core and coil.

8) For inserting the ferrite core into a case, designs should provide adequate clearance between the core and case. The core may break unnecessary force is applied.

9) The insulation resistance of the ferrite core is not high. Do not use it as an insulator. Also, do not use it for other purposes (such as electrical circuit element).

10) For ferrite cores that have low resistivity such as Mn-Zn cores, make sure to provide sufficient insulation with insulation protection covers and tape, etc.

11) When resins such as adhesives, saturants, and coatings are used, excessive stress may arise in the ferrite core owing to the difference in coefficients of thermal expansion, resulting in the core breaking. It is best not to use such resins, but if their use cannot be avoided, use one with a coefficient of thermal expansion that is close to that of the core. In addition, select non-corrosive resin for the core and members to be used.

12) Take note of the following information when selecting members (bobbin, metal fittings, tape, adhesives, saturants, and coatings) to use in combination with the ferrite core.

- ① Members that do not corrode or react.
- ② Members with coefficients of thermal expansion as close as possible to ferrite.
- ③ Members that do not add thermal shock (such as casting chemicals).
- ④ Members that can withstand transformer heat generation, and particularly those that do not were down wires.

13) The coefficients of thermal expansion for the ferrite core and bobbin differ greatly. Securing the core and bobbin with saturants and adhesives will cause the bobbin to expand from heating when the adhesive hardens or heat release during operation. This will place stress on the core, possibly causing it to break. Allow sufficient clearance between the core and bobbin.

14) When there is unbalance from a circuit being split two or more times, the flux will concentrate on the side where the flow is the easiest and may result in abnormal heating and even fire.

15) When a bifilar wiring is made by, for example, a wire container, and the wire gage and length is different or the number of coils are different, the electrical current will tend to flow in only the easiest way, resulting in heating and fire.

16) Designs should keep abnormal current resulting from a problem in another circuit from flowing into the transformer.

17) When used as a transformer, heat will be released. Designs should ensure that surrounding parts will not deteriorate or be destroyed by that heat.

18) Regarding equipment where the user is able to touch the core, make sure to provide extensive warnings and instructions to the user so they will not get shocked or burned by touching the core.

19) Since leakage flux may cause equipment to malfunction, check in advance for its effects on the equipment you are using and ueardy equipment, and then take the appropriate actions.



Notes of Caution on Handling and Usage

1) The ferrite core is a sinter. Make sure to handle it carefully as it has low tolerance for impact such as being knocked or dropped, which may cause it to break or chip. Using it without realizing that it is broken will result in degradation of its properties and heat release. In addition, chipped fragments may result in injury or even get into the eye.

2) The ferrite core is a magnetic substance. When there is a strong magnet nearby, the core will be quickly attracted to it, and there is the possibility that the core will be destroyed by the impact. There is also the danger that a finger or the like may be crushed between the two.

3) The ground surface of the ferrite core has sharp edges because it is not beveled so as to prevent decreased performance. In addition, there may be a minute amount of burr. Carelessly touching it may lead to injury.

4) Do not apply force to the ferrite core beyond the prescribed amount. Otherwise, the core may break or chip the core.

5) Do not allow the ferrite core and jigs or two cores to collide. Failing to observe this may destroy the core(s).

6) When securing the ferrite core, do not apply stress beyond the necessary amount. Failing to observe this may break or chip the core, reducing its properties.

7) Do not expose the ferrite core to rapid temperature extremes (thermal shock). Failing to observe this may break or chip the core.

8) When performing molding or such, the core may break or chip on account of rapid changes in humidity and expansion differences between resins. Carefully evaluate the materials you intend using.

9) There are some ferrite cores that are heavy. Packing boxes may fall over if stacked too high. Limit the height when stacking them.

10) There are some ferrite cores that are heavy. When moving their packing boxes, take due care to prevent injury or backache.

11) Since there is the possibility of damage by vibration, falling, or other sources of physical shock when transporting ferrite cores and transformers that use these cores, take care to provide adequate packing to prevent such damage.

12) The ferrite core should be kept away from rapid temperature changes, corrosive gases, dust, and humidity. Care should also be taken to isolate it from vibration when transporting and storing it.

13) Impact may cause the inductance of ferrite cores to change.

14) If the ferrite core is magnetized once by a strong magnet, it may lose its prescribed properties.

15) If the ferrite core is used for a coil, wrap the wire with the tension appropriate for the core's thickness and the tapering shape. Applying tension beyond the prescribed amount when wrapping the coil may break or chip the core.

16) When the ferrite core is directly used for a coil, the wire may be damaged by the burr on the core's surface, resulting in a short circuit. Select a core that has had its burr removed or has been coated.

17) When the ferrite core is directly used for a coil, the wire may be damaged by tension or friction, resulting in a short circuit. The wire may also be damaged by kinks or the jigs and tools used when adjusting the transformer. Take adequate care when performing work.

18) When wrapping a coil or during assembly, adjust the equipment so that the core is not struck hard and no excessive stress is applied, and make sure to handle it as delicately as possible.

19) The ferrite core should not be placed in the mouth. Make sure to keep it away from young children.

20) Use the ferrite core under normal temperatures and in normal surroundings.

21) If core fragments or other debris get in the ferrite core's ground surface, inductance will lower and howling will result.

22) When cutting the ferrite core, take measures to prevent injury such as providing a cover or protector so that debris and chips will not fly in all directions. In addition, note the following information to prevent the core from breaking or chipping.

- ① Select a grindstone with the properties for the core's qualities.
- ② Adjust cooling agents and their conditions (amount, temperature, and quality).
- ③ For shapes that require a large amount of grinding, do not grind all at once. Instead, grind a little bit at a time.
- ④ Use an exhaust system to prevent the aspiration of dust produced when cutting the ferrite core.



Terms and Definitions

● **Alternating current initial magnetic permeability μ_i**

At the initial magnetization curve's origin point, the magnetic permeability of the magnetic core is used as shown in the formula below.

$$\mu_i = \frac{1}{\mu_0} \lim_{H \rightarrow 0} \frac{B}{H}$$

Here μ_0 : vacuum magnetic permeability
 H : alternating current magnetic field strength (A/m)
 B : alternating current magnetic flux density (T)

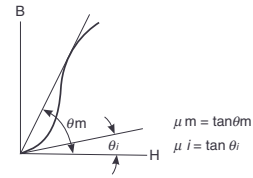

● **Effective magnetic permeability μ_e**

In the magnetic core of a closed magnetic circuit (one in which flux leakage can be ignored), this refers to the magnetic permeability indicated in the following formula through the effective self-inductance.

$$\mu_e = \frac{L \times 10^9}{4\pi N^2} \cdot \sum \frac{\ell}{A}$$

$$\mu_e = \sum \frac{\ell}{A} / \sum \frac{\ell}{\mu A}$$

Here L : effective self-inductance (H)
 N : Number of all windings
 ℓ : Magnetic path lengths (cm) of each of the same materials and same cross-section areas
 A : Each of the cross-section areas (cm²)
 μ : Each of the materials' magnetic permeabilities

Note : The first formula is used in measurement and the second in calculating when the dimensions and magnetic permeabilities of each part of the magnetic core are given.

● **Effective saturation magnetic flux density $B_{ms}(G ; T)$**

This refers to the saturation magnetic flux density in actual use.
 B_{10} : B_{ms} with magnetic field 10 Oe (796A/m)
 B_{15} : B_{ms} with magnetic field 15 Oe (1194A/m)

● **Effective saturation residual coercive force $Br_{ms}(G ; T)$**

This refers to the magnetic flux density when the magnetic field is removed from the condition of effective saturation magnetic flux density.

● **Effective saturation coercive force $H_{cms}(Oe ; A/m)$**

When the magnetic field is removed from the condition of effective saturation magnetic flux density and further magnetized in the opposite direction, this refers to the strength of the magnetic field in which the magnetic flux becomes 0.

● **Loss factor $\tan \delta$**

This refers to the hysteresis loss factor, vortex current loss factor and residual loss factor. The hysteresis loss coefficient (h_1), vortex current loss coefficient (e_1) and residual loss coefficient (r_1) are represented by the following formula.

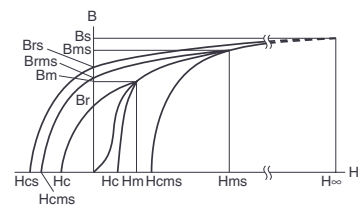

Ba : saturation magnetic flux density
 Bms : effective saturation magnetic flux density
 Bm : maximum magnetic flux density
 Brs : saturation residual magnetic flux density
 Brms : effective saturation residual magnetic flux density
 Br : residual magnetic flux density
 Hcs : saturation coercive force
 Hcms : effective saturation coercive force
 Hc : coercive force
 Hms : effective saturation magnetic field strength
 Hm : maximum magnetic field strength



$$\begin{aligned} \tan \delta &= \frac{R_m}{\omega L} = \frac{R_{eff} - R_w}{\omega L} \\ &= \tan \delta_h + \tan \delta_e + \tan \delta_r \\ &= h_1 \sqrt{\frac{L}{V}} \times i + e_1 f + r_1 \end{aligned}$$

Here R_m : loss resistance (Ω) of the magnetic core alone
 R_{eff} : loss resistance (Ω) of the coil including the magnetic core
 R_w : loss resistance (Ω) of the windings alone
 L : inductance (H) of the coil including the magnetic core
 V : magnetic core volume (mm)
 i : current (A)
 ω : angular frequency $2\pi f$ (rad/s)
 f : frequency (Hz)
 $\tan \delta_h$: hysteresis loss factor
 $\tan \delta_e$: vortex current loss factor
 $\tan \delta_r$: residual loss factor
 h_1 : hysteresis loss coefficient
 e_1 : vortex current loss coefficient
 r_1 : residual loss coefficient
 However with ferrite, separate calculation of $\tan \delta_h$ and $\tan \delta_r$ is difficult, so it is convenient to express them together as follows.

$$\tan \delta = \tan \delta_h + \tan \delta_r$$

● **Relative loss factor $\tan \delta / \mu i$**

This refers to the value of the loss factor divided by the alternating current initial magnetic permeability.

$$\frac{\tan \delta}{\mu_i} = \frac{\mu'' s}{(\mu' s)^2}$$

Note: The following formula applies when the magnetic circuit gap is small.

$$\left(\frac{\tan \delta}{\mu_e} \right) \text{ with gap} \quad \left(\frac{\tan \delta}{\mu_i} \right) \text{ without gap}$$

● **Relative hysteresis loss factor h_{10}**

As shown in the next formula, this refers to the value when $h_1=1000$.

$$h_{10} = h_1 \left(\frac{1000}{\mu} \right)^{\frac{3}{2}}$$

● **Relative temperature factor for initial magnetic permeability $\alpha \mu \gamma$**

"Relative temperature factor for initial magnetic permeability" refers to the "temperature factor for initial magnetic permeability" divided by "initial magnetic permeability" μ_1 .

$$\alpha \mu = \frac{\alpha \mu_1}{\mu_1} = \frac{\mu_2 - \mu_1}{\mu_1} \cdot \frac{1}{T_2 - T_1} \quad (T_2 > T_1)$$

$$\alpha \mu \gamma = \frac{\mu_2 - \mu_1}{\mu_1^2} \cdot \frac{1}{T_2 - T_1} \quad (T_2 > T_1)$$

μ_1 : initial magnetic permeability at temperature T_1

μ_2 : initial magnetic permeability at temperature T_2



- All specifications in this catalog and production status of products are subject to change without notice. Prior to the purchase, please contact NEC TOKIN for updated product data.
- Please request for a specification sheet for detailed product data prior to the purchase.
- Before using the product in this catalog, please read "Precautions" and other safety precautions listed in the printed version catalog.

●Curie temperature Tc (°C)

This refers to the ambient temperature at which the magnetic core shifts from strong magnetism to paramagnetism. In actual practice, to obtain the Curie temperature, the specimen's initial magnetic permeability is measured and the relationship of this to temperature is drawn in a diagram. At the bottom, the extension of the line linking the 80% of maximum point and the 20% of maximum point is taken as the Curie temperature.

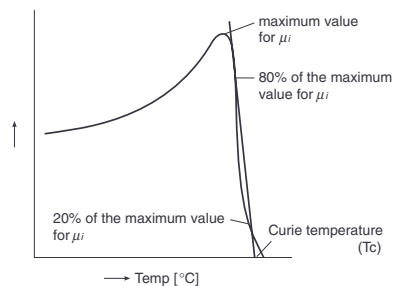

●Disaccommodation factor D_F

This factor applies when the fluctuation of magnetic permeability over time seems to be mostly linear with the time logarithm. It is expressed by the following formula.

$$D_F = \frac{\mu_1 - \mu_2}{\log_{10} \frac{t_2}{t_1}} \cdot \frac{1}{\mu_1^2} \quad (t_2 > t_1)$$

Here μ_1 : following complete demagnetization, the magnetic permeability after the passage of t_1 seconds.

μ_2 : following complete demagnetization, the magnetic permeability after the passage of t_2 seconds.

●Induction factor AL

As shown in the following formula, this refers to self-inductance that occurs per unit winding in a coil of constant shape and dimensions wound around the magnetic core.

$$AL = \frac{L}{N^2}$$

Here L: Self-inductance (H) in the coil when there is a magnetic core

N: Number of all the coil's windings

●Resistance ρ (Ω · m)

This refers to the electrical resistance per unit cross-section area and unit length.

●Density d (kg/m³)

This is calculated as follows from the magnetic core volume and weight.

$$d = \frac{W}{V} \quad (\text{kg/m}^3)$$

Here W: magnetic core weight (kg)

V: magnetic core volume (m³)

For the most part the preceding definitions are based on JIS C2560 "Ferrite Magnetic Core Regulations."



High-B Compound Standard Material Characteristics

Material Model			BH1	BH2	BH3	BH5	BH7	B40	
Initial permeability	μ_i		2300±20%	2300±20%	1800±20%	2300±20%	1600±20%	1500±20%	
Relative hysteresis loss factor	$\tan\delta/\mu_i \times 10^{-6}$		<5	<6	<5	<5	<8	<3	
Core loss	P _{cv}	kW/m ³	100kHz	23°C	550	600	600	600	1250
				60°C	400	450	430	430	1100
			200mT	80°C	320	430	380	400	
				100°C	300	410	370	450	1350
				23°C	680	730		500	
			300kHz	60°C	500	520		330	
			100mT	80°C	430	470		300	
				100°C	400	450		340	
			500kHz	60°C				790	
				80°C				780	
1MHz	60°C						360		
50mT	80°C						380		
Curie temperature	T _c	°C	220	220	260	220	350	240	
Effective saturation magnetic flux density	B _{ms}	mT	23°C	520	510	540	520	600	
			100°C	410	400	440	410	490	
Effective saturation residual coercive force	B _{rms}	mT	23°C	100	100	200	120	185	
			100°C	55	55	80	70	220	
Effective saturation coercive force	H _c	A/m	23°C	13	14.3	15	19	17.0	
Density	d	kg/m ³		4.8×10 ³	4.8×10 ³	4.8×10 ³	4.8×10 ³	4.9×10 ³	

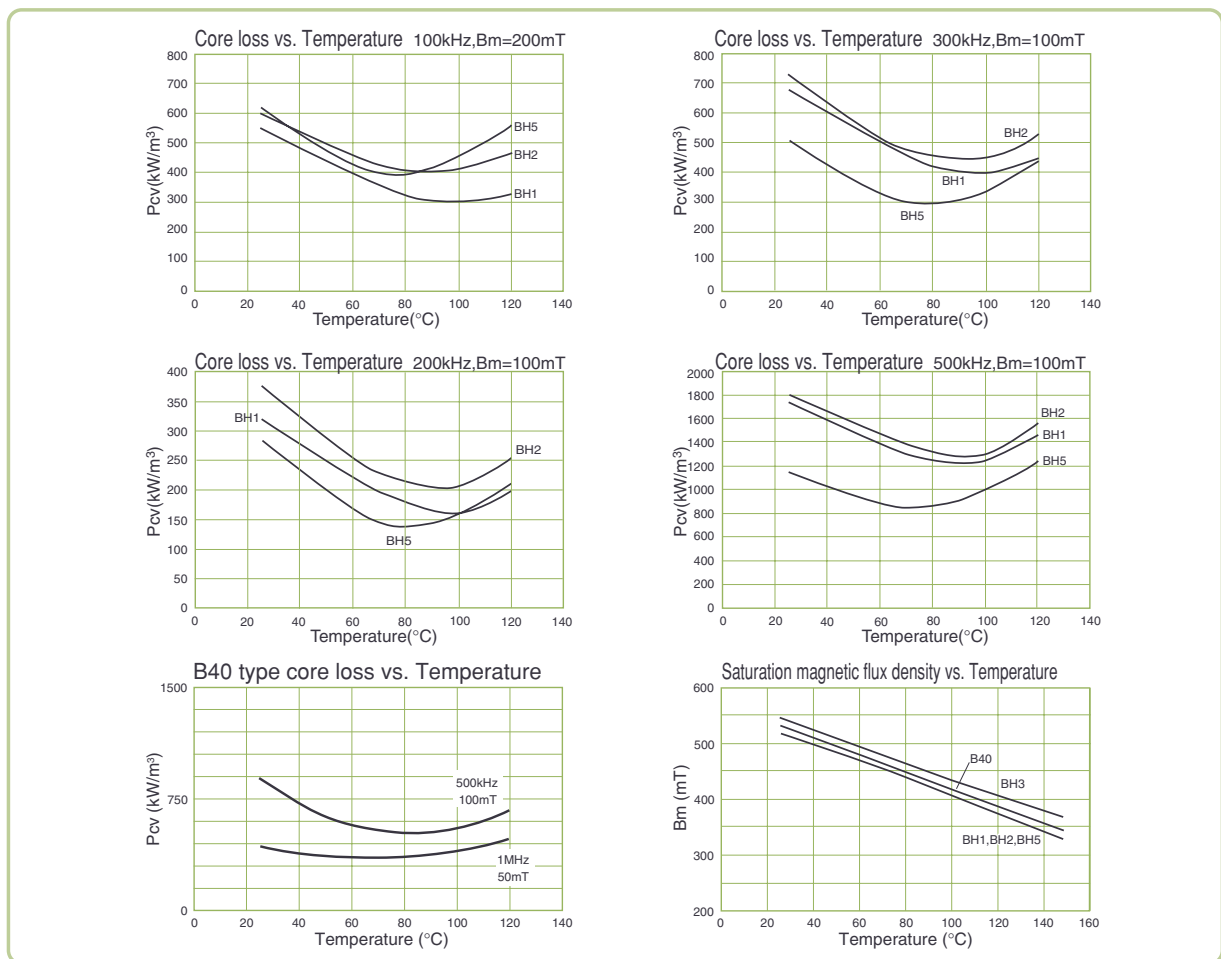

- All specifications in this catalog and production status of products are subject to change without notice. Prior to the purchase, please contact NEC TOKIN for updated product data.
- Please request for a specification sheet for detailed product data prior to the purchase.
- Before using the product in this catalog, please read "Precautions" and other safety precautions listed in the printed version catalog.

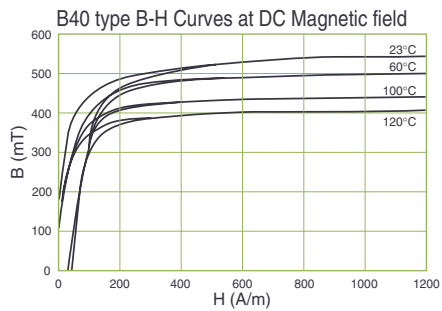
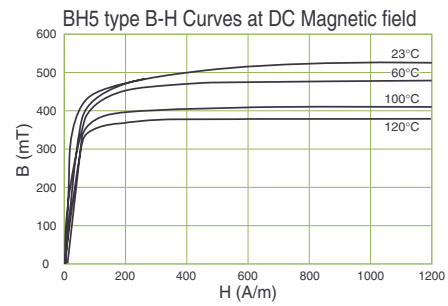
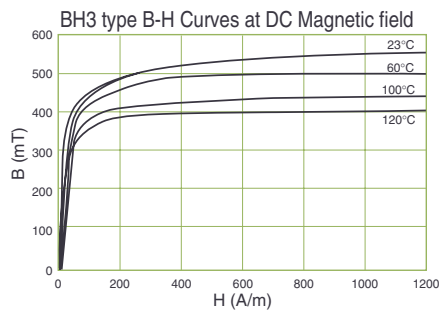
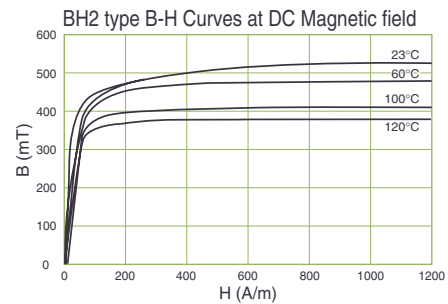
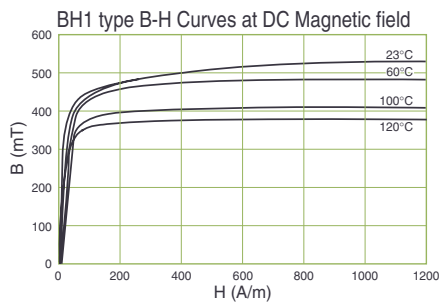
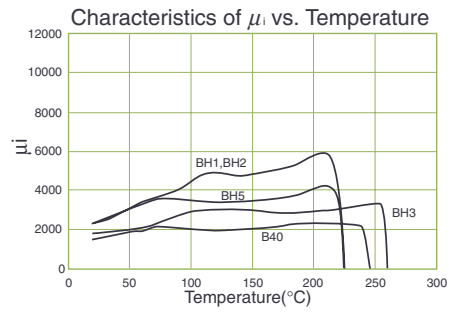
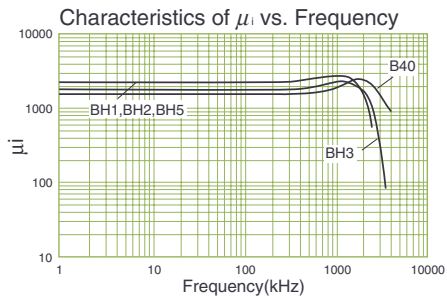

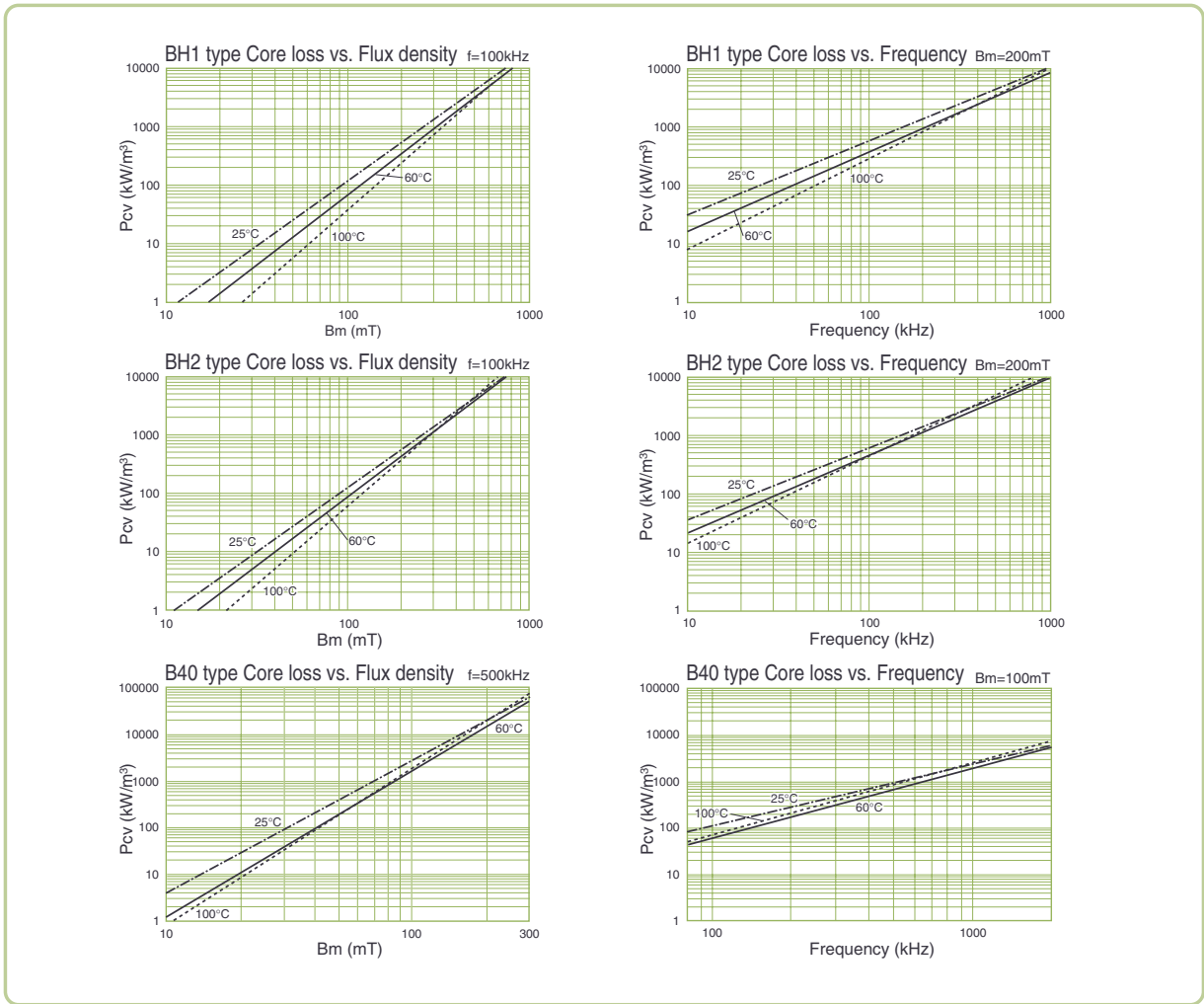

- All specifications in this catalog and production status of products are subject to change without notice. Prior to the purchase, please contact NEC TOKIN for updated product data.
- Please request for a specification sheet for detailed product data prior to the purchase.
- Before using the product in this catalog, please read "Precautions" and other safety precautions listed in the printed version catalog.

High- μ Compound Standard Material Characteristics

Material Model				5H	7H	10H	12H	15H
Initial permeability	μ_i			5000±25%	7000±25%	10000±30%	12000±30%	15000±30%
Effective saturation magnetic flux density	B _{rms}	23°C	mT	460 (H=800A/m)	460 (H=800A/m)	430 (H=800A/m)	420 (H=800A/m)	430 (H=800A/m)
Effective saturation residual coercive force	B _{rms}	23°C	mT	75	75	100	100	80
Effective saturation coercive force	H _{cms}	23°C	A/m	7.0	5.0	3.5	3.2	2.0
Relative loss factor	$\tan\delta/\mu_i$		$\times 10^{-6}$	<10 (100kHz)	<10 (100kHz)	<7 (10kHz)	<7 (10kHz)	<7 (10kHz)
Curie temperature	T _c		°C	>130	>130	>120	>125	>120
Disaccommodation factor	DF		$\times 10^{-6}$	<3.0	<2.0	<2.0	<2.0	<2.0
Density	d		kg/m ³	4.9×10 ³	4.9×10 ³	4.9×10 ³	4.9×10 ³	5.0×10 ³

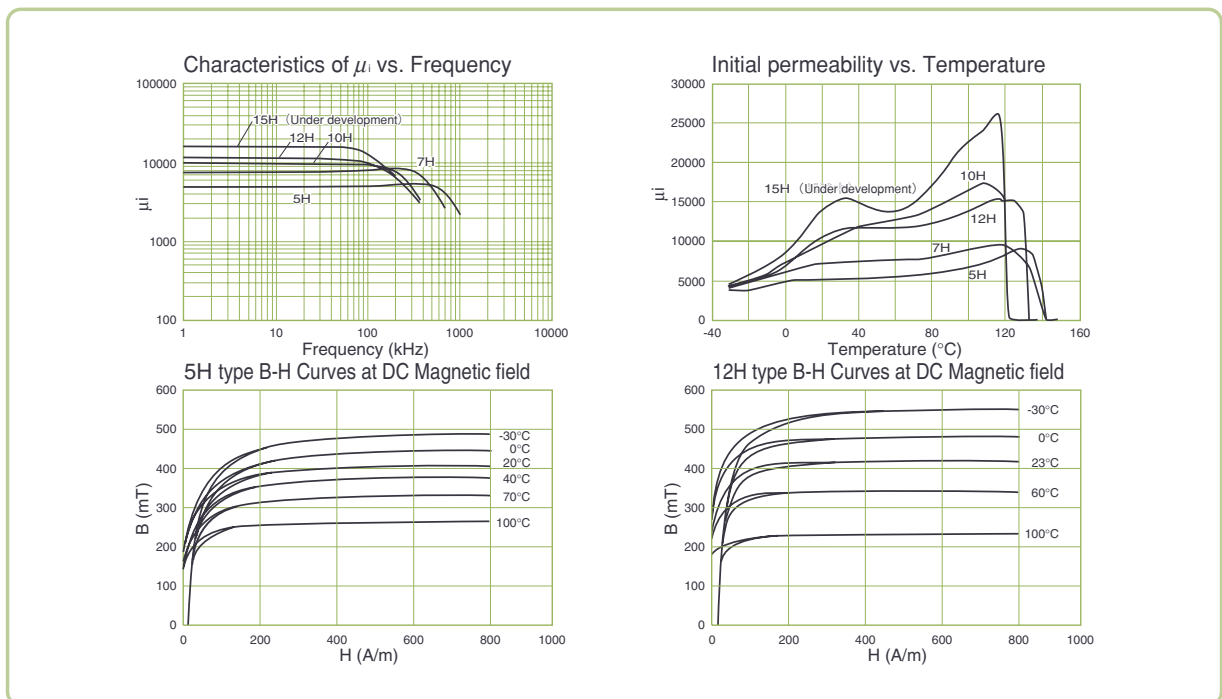

- All specifications in this catalog and production status of products are subject to change without notice. Prior to the purchase, please contact NEC TOKIN for updated product data.
- Please request for a specification sheet for detailed product data prior to the purchase.
- Before using the product in this catalog, please read "Precautions" and other safety precautions listed in the printed version catalog.

E Type Ferrite Cores

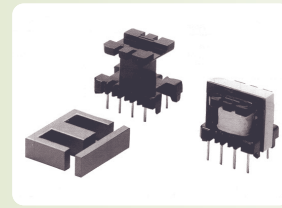

Cores	Bobbins	Type	Dimensions[mm]		
			A	B	C
FEI12.5					
FEI16,FEE16	EB16-P1206-F	Vertical type	17	15.5	15.5
FEI19,FEE19	EB19-P1207-F	Vertical type	20	16	16.5
FEE19W	EB19W-P1208-F	Vertical type	20	19	28
FEI22,FEE22	EB22-P1210-F	Vertical type	23.5	18	21
	EB22-P1110-FA	Horizontal type	23.5	25.5	18
FEI22S					
FEI25	EB25-P1208-F	Vertical type	26.5	18	22
FEI25S					
FEI28	EB28-P1210-F	Vertical type	30	25	23
	EB28-P1212-F				
FEI30,FEE30	EB30-P1208-F	Vertical type	32	26	29.5
	EB30-P1212-F				
FEI33					
FEI35					
FEI35S	EB35S-P1212-F	Vertical type	37	28.5	33
	EB40-P1210-F	Vertical type	42	29	38
FEI40,FEE40	EB40-P1212-F				
	EB40-P1114-FA	Horizontal type	43	40	33
FEE42/15					
FEE42/20					
FEI44					
FEI50,FEE50					
FEI60,FEE60					

Shape and Dimensions

● Vertical type

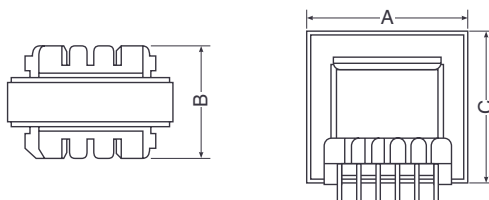

● Horizontal type

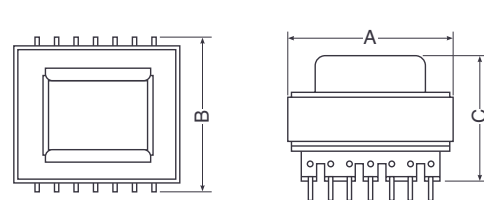

- All specifications in this catalog and production status of products are subject to change without notice. Prior to the purchase, please contact NEC TOKIN for updated product data.
- Please request for a specification sheet for detailed product data prior to the purchase.
- Before using the product in this catalog, please read "Precautions" and other safety precautions listed in the printed version catalog.

FEI-Type Cores

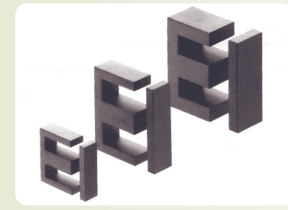

Cores	JIS	C ₁ (mm ⁻¹)	A _e (mm ²)	ℓ _e (mm)	V _e (mm ³)	A _{cp} (mm ²)	A _{cw} (mm ²)	AL(nH) BH1,BH2	Weight (g)
FEI12.5	FEI12.5	1.42	15.2	21.6	328	12	17	1400±25%	1.9
FEI16	FEI16	1.79	19.4	34.6	670	19.2	40	1200±25%	3.2
FEI19	FEI19	1.74	22.7	39.8	910	22.5	57	1300±25%	4.4
FEI22	FEI22	0.95	41.7	39.3	1639	33.1	40	2400±25%	8.8
FEI22S		1.16	36.2	42.1	1525	33.1	57	2000±25%	7.7
FEI25	FEI25.4	1.14	41.2	47	1934	43.9	99	2000±25%	11.0
FEI28	FEI28	0.57	85.1	48.6	4139	77	71	4000±25%	24.0
FEI30	FEI30	0.52	111	58.1	6457	115	77	4700±25%	35.0
FEI33	FEI33	0.57	118.1	66.9	7909	124	136	4300±25%	41.5
FEI35	FEI35A	0.68	99.9	67.3	6700	97	127	3650±25%	36.2
FEI35S	FEI35C	0.56	120	67.3	8090	117	137	4400±25%	41.5
FEI40	FEI40	0.52	140	76.8	11378	135.7	163	4750±25%	61.0
FEI44	FEI44	0.46	190	86.5	16400	176	224	5400±25%	82.7
FEI50	FEI50	0.41	230	94.7	21780	231.2	249	5950±25%	110.0
FEI60	FEI60	0.44	247	109	27148	243.4	409	5500±25%	140.0

Shape and Dimensions

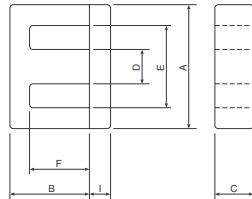

Cores	JIS	A	B	C	D	E(min)	F	I
FEI12.5	FEI12.5	12.5±0.2	7.3 ^{+0.2} ₋₀	5±0.2	2.5 ⁺⁰ _{-0.2}	9.0	5 ^{+0.2} ₋₀	1.5±0.1
FEI16	FEI16	16±0.3	12 ^{+0.4} ₋₀	5 ⁺⁰ _{-0.4}	4±0.2	11.8	10 ^{+0.4} ₋₀	1.5±0.1
FEI19	FEI19	19.1±0.3	13.3 ^{+0.4} ₋₀	5.2 ⁺⁰ _{-0.4}	4.7 ⁺⁰ _{-0.4}	14.4	11 ^{+0.5} ₋₀	2.3±0.1
FEI22	FEI22	22±0.3	14.3 ^{+0.5} ₋₀	6 ⁺⁰ _{-0.5}	6 ⁺⁰ _{-0.5}	13.0	10.3 ^{+0.5} ₋₀	4.5±0.2
FEI22S		22±0.4	14.4 ^{+0.5} ₋₀	6 ⁺⁰ _{-0.5}	6 ⁺⁰ _{-0.5}	16.0	10.6 ^{+0.4} ₋₀	4±0.2
FEI25	FEI25.4	25.3±0.5	15.3 ^{+0.5} ₋₀	7 ⁺⁰ _{-0.5}	6.8 ⁺⁰ _{-0.6}	19.2	12.2 ^{+0.4} _{-0.1}	2.7±0.2
FEI28	FEI28	28±0.5	16.5 ^{+0.5} ₋₀	11 ⁺⁰ _{-0.6}	7.5 ⁺⁰ _{-0.6}	18.8	12 ^{+0.5} ₋₀	3.5±0.3
FEI30	FEI30	30±0.5	21 ^{+0.5} ₋₀	11 ⁺⁰ _{-0.6}	11 ⁺⁰ _{-0.6}	19.8	16 ^{+0.5} ₋₀	5.5±0.2
FEI33	FEI33	33±0.5	23.3±0.3	13 ⁺⁰ _{-0.6}	10 ⁺⁰ _{-0.6}	23.2	18.8 ^{+0.5} ₋₀	5±0.2
FEI35	FEI35A	35 ^{+0.8} _{-0.5}	23.8 ^{+0.7} ₋₀	10 ⁺⁰ _{-0.5}	10.3 ⁺⁰ _{-0.6}	25.0	18 ^{+0.6} ₋₀	5.5±0.2
FEI35S	FEI35C	35 ^{+0.8} _{-0.5}	23.8 ^{+0.7} ₋₀	12 ⁺⁰ _{-0.6}	10.3 ⁺⁰ _{-0.6}	25.0	18 ^{+0.6} ₋₀	5.5±0.2
FEI40	FEI40	40±0.5	27 ^{+0.5} ₋₀	12 ⁺⁰ _{-0.7}	12 ⁺⁰ _{-0.7}	27.2	20 ^{+0.5} ₋₀	7.5±0.3
FEI44	FEI44	44±0.6	30 ^{+0.5} ₋₀	15.3 ⁺⁰ _{-0.6}	12 ⁺⁰ _{-0.6}	31.2	23 ^{+0.5} ₋₀	7.0±0.3
FEI50	FEI50	50±0.7	33 ^{+0.7} ₋₀	15 ⁺⁰ _{-0.8}	15 ⁺⁰ _{-0.8}	34.0	24.5 ^{+0.5} ₋₀	9±0.3
FEI60	FEI60	60±0.8	35.5 ^{+0.7} ₋₀	16 ⁺⁰ _{-0.8}	16 ⁺⁰ _{-0.8}	44.1	27.5 ^{+0.7} ₋₀	8.5±0.3

[mm]

Numbering System

FEI22 - BH2

① ②

① Core size FEI : FEI-type FEE : FEE-type
② Core material



- All specifications in this catalog and production status of products are subject to change without notice. Prior to the purchase, please contact NEC TOKIN for updated product data.
- Please request for a specification sheet for detailed product data prior to the purchase.
- Before using the product in this catalog, please read "Precautions" and other safety precautions listed in the printed version catalog.

FEE-Type Cores

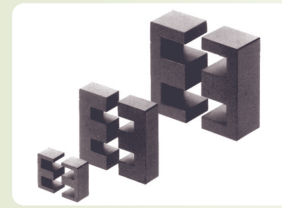

Cores	JIS	C _i (mm ⁻¹)	A _e (mm ²)	ℓ _e (mm)	V _e (mm ³)	A _{cp} (mm ²)	A _{cw} (mm ²)	AL(nH) BH1,BH2	Weight (g)
FEE10/11		2.16	12.1	26.1	315	11.6	22.9	850±25%	1.5
FEE12.5W		2.1	14.9	31.4	469	12	34.7	950±25%	2.4
FEE16	FEE16A	1.8	19	34.8	670	19	40	1200±25%	3.3
FEE16W		2.9	19	55.1	1048	19.2	82.6	750±25%	5.2
FEE19	FEE19A	1.73	23	39.8	910	23	57	1250±25%	4.8
FEE19W		2.78	22.4	62.2	1393	22.5	114	800±25%	7.0
FEE19/16/5	E187	1.75	22.8	39.9	907	22.2	54.9	1250±25%	7.0
FEE22		0.98	41	39.8	1620	33	40	2200±25%	8.8
FEE22W		1.48	40	59.2	2370	33.1	79.7	1500±25%	11.9
FEE22SW		1.82	35	63.6	2220	33.1	114	1250±25%	11.1
FEE25Z		1.20	41.4	49.8	2060	43.9	87.1	2090±25%	10.3
FEE25W		1.73	41.7	72.1	3010	43.9	159	1400±25%	15.0
FEE28/12.5/10.9		0.72	82.6	59.3	4893	84.5	108	3500±25%	24.5
FEE28W		0.83	87.7	73.2	6421	77	146	3000±25%	32.1
FEE28S		0.564	87	49.3	4310	78	73	4450±25%	21.5
FEE30W		0.829	111	90.2	9820	115	154	3000±25%	49.1
FEE33W		0.886	118	104.7	12380	124	271	2830±25%	61.9
FEE34/28/9	E375	0.850	81.6	69.37	5660	85.7	162.6	2950±25%	36.0
FEE35W		1.06	100	105.2	10410	97	282	2360±25%	52.1
FEE35SW		0.88	120	105.2	12560	117	274	2800±25%	62.8
FEE40/44.6/11		0.67	145	97.2	14110	136	244	3750±25%	70.5
FEE40W		0.817	148	117	16770	136	326	3070±25%	83.9
FEE41/33/12	E21	0.517	149.8	77.38	11591	155.0	175.7	4850±25%	60.0
FEE42/15		0.563	176	98.8	17300	183	275	4460±25%	97.5
FEE42/20		0.417	237	98.3	23200	242	275	6000±25%	130.0
FEE44W		0.717	190	132.9	24700	176	448	3500±25%	123.3
FEE50W		0.626	230	142.3	32350	213	498	4000±25%	161.8
FEE60W		0.68	247	165.2	40140	243	818	3700±25%	200.7



- All specifications in this catalog and production status of products are subject to change without notice. Prior to the purchase, please contact NEC TOKIN for updated product data.
- Please request for a specification sheet for detailed product data prior to the purchase.
- Before using the product in this catalog, please read "Precautions" and other safety precautions listed in the printed version catalog.

Shape and Dimensions

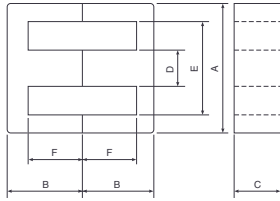

Cores	JIS	A	B	C	D	E(min)	F
FEE10/11		10.2±0.2	5.5±0.1	4.75±0.15	2.45±0.15	7.7	4.2±0.15
FEE12.5W		12.5 ^{+0.4} _{-0.2}	7.3 ^{+0.2} ₋₀	5±0.2	2.5 ⁺⁰ _{-0.2}	9.0	5 ^{+0.2} ₋₀
FEE16	FEE16A	16±0.3	7 ^{+0.3} ₋₀	5 ⁺⁰ _{-0.4}	4.2 ⁺⁰ _{-0.4}	11.8	5 ^{+0.2} ₋₀
FEE16W		16±0.3	12 ^{+0.4} ₋₀	5 ⁺⁰ _{-0.4}	4±0.2	11.8	10 ^{+0.4} ₋₀
FEE19	FEE19A	19.1±0.3	7.8 ^{+0.3} ₋₀	5.2 ⁺⁰ _{-0.4}	4.7 ⁺⁰ _{-0.4}	14.4	5.5 ^{+0.3} ₋₀
FEE19W		19.1±0.3	13.3 ^{+0.4} ₋₀	5.2 ⁺⁰ _{-0.4}	4.7 ⁺⁰ _{-0.4}	14.3	11 ^{+0.5} ₋₀
FEE19/16/5	E187	19.3±0.3	7.92 ^{+0.26} ₋₀	4.75±0.13	4.68±0.15	14.05	5.57 ^{+0.25} ₋₀
FEE22		22±0.3	9.2 ^{+0.3} ₋₀	6 ⁺⁰ _{-0.5}	6 ⁺⁰ _{-0.5}	13.0	5.2 ^{+0.3} ₋₀
FEE22W		22±0.3	14.3 ^{+0.5} ₋₀	6 ⁺⁰ _{-0.5}	6 ⁺⁰ _{-0.5}	12.8	10.3 ^{+0.5} ₋₀
FEE22SW		22 ^{+0.6} _{-0.3}	14.4 ^{+0.5} ₋₀	6 ⁺⁰ _{-0.5}	6 ⁺⁰ _{-0.5}	15.6	10.6 ^{+0.4} ₋₀
FEE25Z		25.3 ^{+0.6} _{-0.5}	9.95±0.2	7 ⁺⁰ _{-0.5}	6.8 ⁺⁰ _{-0.6}	19.2	6.75±0.2
FEE25W		25.3 ^{+0.6} _{-0.5}	15.3 ^{+0.5} ₋₀	7 ⁺⁰ _{-0.5}	6.8 ⁺⁰ _{-0.6}	19	12.2 ^{+0.4} _{-0.1}
FEE28/12.5/10.9		28±0.5	12.5±0.2	10.9 ⁺⁰ _{-0.4}	8 ^{+0.1} _{-0.3}	20	8.5 ^{+0.4} ₋₀
FEE28W		28 ^{+0.7} _{-0.5}	16.5 ^{+0.5} ₋₀	11 ⁺⁰ _{-0.6}	7.5 ⁺⁰ _{-0.6}	18.6	12 ^{+0.5} ₋₀
FEE28S		28.0±0.4	10.5±0.5	11.0 ⁺⁰ _{-0.6}	7.5 ⁺⁰ _{-0.5}	18.6	6.2±0.2
FEE30W		30.0±0.5	21.0 ^{+0.5} ₋₀	11.0 ⁺⁰ _{-0.6}	11.0 ⁺⁰ _{-0.6}	19.5	16.0 ^{+0.5} ₋₀
FEE33W		33.0 ^{+1.0} _{-0.5}	23.3±0.3	13.0 ⁺⁰ _{-0.6}	10.0 ⁺⁰ _{-0.6}	23.0	18.8 ^{+0.5} ₋₀
FEE34/28/9		34.4±0.5	13.97 ^{+0.3} ₋₀	9.2±0.3	9.32±0.2	25.4	9.7 ^{+0.2} ₋₀
FEE35W		35.0 ^{+0.8} _{-0.5}	23.8 ^{+0.7} ₋₀	10.0 ⁺⁰ _{-0.6}	10.3 ⁺⁰ _{-0.6}	24.6	18.0 ^{+0.6} ₋₀
FEE35SW		35.0 ^{+0.8} _{-0.5}	23.8 ^{+0.7} ₋₀	12.0 ⁺⁰ _{-0.6}	10.3 ⁺⁰ _{-0.6}	24.6	18.0 ^{+0.6} ₋₀
FEE40/44.6/11		40.0 ^{+0.9} _{-0.5}	22.3±0.3	12.0 ⁺⁰ _{-0.7}	12.0 ⁺⁰ _{-0.7}	26.8	15.3±0.3
FEE40W		40.0±0.5	27.0 ^{+0.5} ₋₀	12.0 ⁺⁰ _{-0.7}	12.0 ⁺⁰ _{-0.7}	27.2	20.0 ^{+0.5} ₋₀
FEE41/33/12		40.64±0.6	16.31 ^{+0.35} ₋₀	12.45±0.25	12.45±0.25	28.55	10.42 ^{+0.24} ₋₀
FEE42/15		42.0±0.5	21.0 ^{+0.6} ₋₀	15.2 ⁺⁰ _{-0.6}	12.5 ⁺⁰ _{-0.5}	30.0	15.5 ^{+0.5} ₋₀
FEE42/20		42.0±0.5	21.0 ^{+0.6} ₋₀	20.0 ⁺⁰ _{-0.5}	12.5 ⁺⁰ _{-0.5}	30.0	15.5 ^{+0.5} ₋₀
FEE44W		44.0±0.6	30.0 ^{+0.5} ₋₀	15.3 ⁺⁰ _{-0.6}	12.0 ⁺⁰ _{-0.6}	31.2	23.0 ^{+0.5} ₋₀
FEE50W		50.0±0.7	33.0 ^{+0.7} ₋₀	15.0 ⁺⁰ _{-0.8}	15.0 ⁺⁰ _{-0.8}	34.0	24.5 ^{+0.5} ₋₀
FEE60W		60.0±0.8	35.5 ^{+0.7} ₋₀	16.0 ⁺⁰ _{-0.8}	16.0 ⁺⁰ _{-0.8}	44.1	27.5 ^{+0.7} ₋₀

[mm]

Numbering System

FEI22 - BH2

① ②

① Core size FEI : FEI-type FEE : FEE-type
 ② Core material



- All specifications in this catalog and production status of products are subject to change without notice. Prior to the purchase, please contact NEC TOKIN for updated product data.
- Please request for a specification sheet for detailed product data prior to the purchase.
- Before using the product in this catalog, please read "Precautions" and other safety precautions listed in the printed version catalog.

E-Type Bobbins

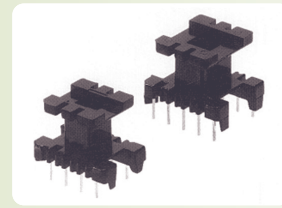

Bobbins	Type	ϕP	P1 (mm)	P2 (mm)	P3 (mm)	Number of pins	Aw (mm ²)	ℓw (mm)	Weight (g)
EB16-P1206-F	3	0.7	3.25	6.5	10.65	6	22.4	37.6	0.91
EB19-P1207-F	3	0.7	4.0	12.0	11.0	7	33.6	41	1.0
EB19W-P1208-F	1	0.8	3.75	12.5	12.5	8	62.4	49.6	3.0
EB22-P1210-F	1	0.8	4.0	16.0	12.05	10	19	42	2
EB22-P1110-FA	2	0.8	5.08	20.32	12.7	10	22.3	41	4.3
EB25-P1208-F	1	0.8	5.0	15.0	12.5	8	42.3	53	2.8
EB28-P1210-F	1	0.8	5.0	20.0	17.5	10	42.4	63	3.2
EB28-P1212-F	1	0.8	5.0	25.0	18.0	12	45.3	64	3.5
EB30-P1208-F	3	0.8	5.0	15.0	17.5	8	43.1	62	2.0
EB30-P1212-F	1	0.8	5.0	25.0	20.0	12	40	65	4.9
EB35S-P1212-F	1	0.8	5.0	27.5	20.0	12	85.7	78	6.4
EB40-P1210-F	3	0.8	5.0	20.0	25.0	10	105	76	5.2
EB40-P1212-F	1	0.8	5.0	25.0	22.5	12	120	76	6.7
EB40-P1114-FA	2	1.0	5.08	30.48	22.86	14	104.8	79.1	11.5

Shape and Dimensions

● Type 1

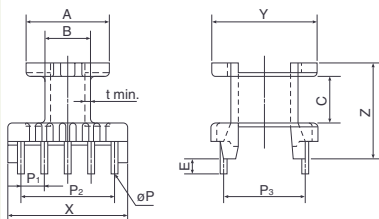

● Type 2

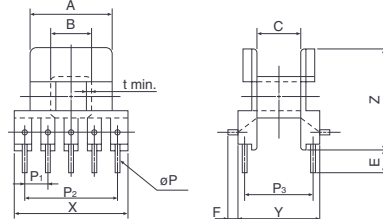

● Type 3

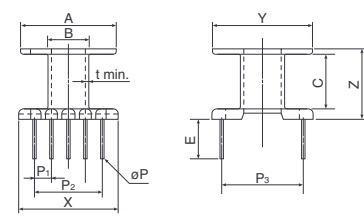

Bobbins	Type	A	B	C	E	X	Y	Z	t (min)
EB16-P1206-F	3	11.5	5.6	7.6	5.5	11.5	14	12.2	0.5
EB19-P1207-F	3	14.8	5.75	8.2	6	14.8	14.8	12	0.4
EB19W-P1208-F	1	13.8	7.3	19.2	6.5	17.5	17.7	29.3	0.8
EB22-P1210-F	1	12.6	7.95	8.35	6	20	15	16	0.85
EB22-P1110-FA	2	12.5	7.7	8.7	5	24	18.4	16.95	0.55
EB25-P1208-F	1	17.5	8.95	9.9	3.5	25	17.5	19.3	0.85
EB28-P1210-F	1	18.3	9.65	9.8	3.5	26	21.5	20.525	0.85
EB28-P1212-F	1	18.45	9.4	10	6.5	28.2	23.5	17	0.7
EB30-P1208-F	3	19.05	12.75	13.75	14.5	19.05	22	16.75	0.5
EB30-P1212-F	1	19.2	13.3	13.6	4.5	30	25	24.4	0.9
EB35S-P1212-F	1	23.9	12.64	15.425	5	34.5	27.5	27.425	0.9
EB40-P1210-F	3	26.35	14.15	17.2	16.5	26.35	30	22.4	0.7
EB40-P1212-F	1	26.5	14.3	17.7	4.5	32	28	15.6	0.9
EB40-P1114-FA	2	26.5	14.7	17.8	8	40	35	31.5	1.05

[mm]

Numbering System

FB 22 - P12 10 - F

① ② ③ ④

- ① Core size
- ② P12: Vertical type, P11: Horizontal type
- ③ Number of pins
- ④ Material : Phenol resin



- All specifications in this catalog and production status of products are subject to change without notice. Prior to the purchase, please contact NEC TOKIN for updated product data.
- Please request for a specification sheet for detailed product data prior to the purchase.
- Before using the product in this catalog, please read "Precautions" and other safety precautions listed in the printed version catalog.

FEER Type Ferrite Cores

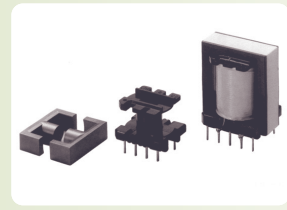

Cores	Bobbins	Type	Dimensions[mm]		
			A	B	C
FEER28	ERB28-P1210-F	Vertical type	28.0	24.0	29.0
FEER28L	ERB28L-P1212-F	Vertical type	28.0	24.0	35.0
FEER29					
FEER30					
FEER34					
FEER35	ERB35-P1212-F	Vertical type	35.0	28.0	35.0
FEER35L					
FEER39					
FEER39L	ERB39L-P1212-F	Vertical type	39.0	29.5	47.5
FEER40					
FEER42					
FEER42I					
FEER42A	ERB42A-P1214-F	Vertical type	42.0	34.5	42.5
FEER43					
FEER44					
FEER49					

Shape and Dimensions

● Vertical type

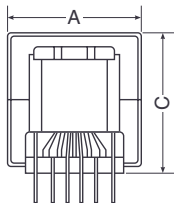
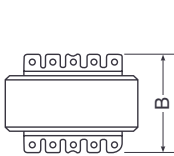

● Horizontal type

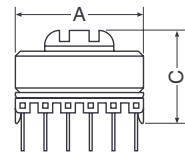
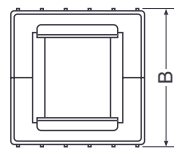

FEER-Type Cores

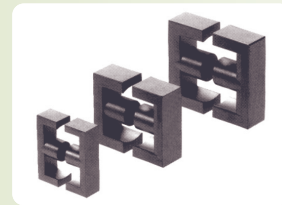

Cores	JIS	C _i (mm ⁻¹)	A _e (mm ²)	ℓ _e (mm)	V _e (mm ³)	A _{cp} (mm ²)	A _{cw} (mm ²)	AL(nH) BH1,BH2	Weight (g)
FEER22S		0.301	35.0	55.4	1940	35.0	68.0	1700±25%	10.0
FEER22		1.665	37.5	62.4	2340	34.7	97.9	1400±25%	12.0
FEER25.5	FEER25.5A	1.16	43.2	50.0	2157	44.2	80.3	2050±25%	10.8
FEER28	FEER28.5A	0.78	85.3	66.8	5702	77.0	114.8	3000±25%	28.5
FEER28L	FEER28.5B	0.95	84.7	78.3	6635	77.0	149.1	2540±25%	33.2
FEER29		0.99	75.0	74.3	5590	71.0	145.0	2500±25%	27.0
FEER34	FEER34.2	0.86	96.6	83.0	8014	91.6	186.3	2930±25%	41.5
FEER35		0.72	110.1	79.0	8695	100.3	160.9	3500±25%	45.0
FEER35L	FEER35A	0.87	108.4	94.5	10248	100.3	220.5	2900±25%	50.7
FEER39	FEER39.1	0.79	123.2	97.1	11970	122.7	259.9	3200±25%	60.0
FEER39L	FEER39	0.80	131.9	106.1	13993	128.7	280.5	3150±25%	70.0
FEER40		0.67	152.8	102.4	15637	138.9	247.9	3750±25%	78.1
FEER4042		0.63	15.0	100.0	15756	153.9	256.5	4000±25%	72.1
FEER42		0.56	182.5	101.8	18574	181.5	241.0	4550±25%	87.6
FEER42L		0.48	239.0	113.6	27180	235.0	232.7	5300±25%	135.9
FEER42A		0.44	232.5	101.4	23572	235.1	228.8	5700±25%	118.0
FEER44	FEER44	0.63	172.0	108.7	18707	172.0	306.7	4000±25%	88.6
FEER49		0.42	229.1	97.2	22263	232.4	245.5	6000±25%	110.0

Shape and Dimensions

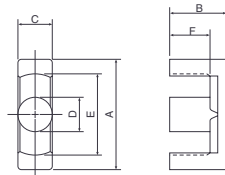

Cores	JIS	A	B	C	D	E(min)	F
FEER22S		22.0±0.4	11.1	6.65±0.25	6.65±0.25	15.5	7.1 ^{+0.3} ₋₀
FEER22		22.0±0.3	14.7±0.15	6.65±0.15	6.65±0.1	15.5	10.7±0.15
FEER25.5	FEER25.5A	25.5±0.5	9.3±0.2	7.5±0.2	7.5±0.15	19.8	6.2±0.2
FEER28	FEER28.5A	28.5 ^{+0.6} _{-0.5}	14.0±0.2	11.4±0.25	9.9±0.25	21.2	9.6 ^{+0.3} _{-0.2}
FEER28L	FEER28.5B	28.5 ^{+0.6} _{-0.5}	16.9±0.25	11.4±0.25	9.9±0.25	21.2	12.5 ^{+0.3} _{-0.25}
FEER29		30.6 ⁺⁰ _{-1.6}	15.8±0.2	9.8 ⁺⁰ _{-0.6}	9.8 ⁺⁰ _{-0.6}	22.0	11.0±0.13
FEER34	FEER34.2	35.0 ⁺⁰ _{-1.6}	17.3±0.2	11.1 ⁺⁰ _{-0.6}	11.1 ⁺⁰ _{-0.6}	25.5	11.8 ^{+0.6} ₋₀
FEER35		35.0±0.7	16.8±0.3	11.3±0.25	11.3±0.25	25.6	10.8±0.3
FEER35L	FEER35A	35.0±0.5	20.7±0.3	11.3±0.25	11.3±0.25	25.6	14.7±0.3
FEER39	FEER39.1	38.9 ^{+1.1} _{-0.7}	20.0 ⁺⁰ _{-0.4}	12.8 ⁺⁰ _{-0.6}	12.8 ⁺⁰ _{-0.6}	29.3	14.2 ^{+0.8} ₋₀
FEER39L	FEER39	39.0±0.6	22.2±0.3	12.8±0.25	12.8±0.2	28.7	17.0±0.25
FEER40		40.0±0.5	22.4±0.2	13.3±0.25	13.3±0.25	29.0	15.4±0.25
FEER4042		40.0±0.5	21.0±0.2	15.0±0.2	14.0±0.25	30.7	15.0±0.2
FEER42		42.0±0.6	21.2±0.2	15.2±0.2	15.2±0.2	30.5	15.0 ^{+0.5} ₋₀
FEER42L		42.0 ^{+0.8} _{-0.5}	25.4±0.2	17.3±0.25	17.3±0.25	29.8	17.9±0.2
FEER42A		42.0±0.5	21.2±0.2	20.0 ⁺⁰ _{-0.8}	17.3±0.25	31.8	15.0 ^{+0.5} ₋₀
FEER44	FEER44	43.8 ^{+1.2} _{-0.8}	22.5 ⁺⁰ _{-0.4}	15.2 ⁺⁰ _{-0.8}	15.2 ⁺⁰ _{-0.8}	32.5	16.1 ^{+0.6} ₋₀
FEER49		49.0±0.8	18.8 ^{+0.5} _{-0.1}	17.2±0.2	17.2±0.2	36.5	12.2 ^{+0.4} ₋₀

[mm]

Numbering System

FEER 28L BH2

① ②

- ① Core size
- ② Core material



- All specifications in this catalog and production status of products are subject to change without notice. Prior to the purchase, please contact NEC TOKIN for updated product data.
- Please request for a specification sheet for detailed product data prior to the purchase.
- Before using the product in this catalog, please read "Precautions" and other safety precautions listed in the printed version catalog.

FEER-Type Bobbins

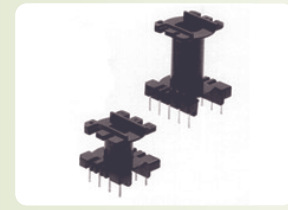

Bobbins	Type	ϕP	P1 (mm)	P2 (mm)	P3 (mm)	Number of pins	Aw (mm ²)	ℓw (mm)	Weight (g)
ERB28-P1210-F	1	0.8	5	20	17.5	10	68	52	4.4
ERB28L-P1212-F	1	0.8	5	25	17.5	12	94.6	52	4.3
ERB35-P1212-F	1	1.0	5	25	22.5	12	103	58.6	7.2
ERB42A-P1214-F	1	0.7	5	30	30.0	14	156	80.7	9.5

Shape and Dimensions

● Type 1

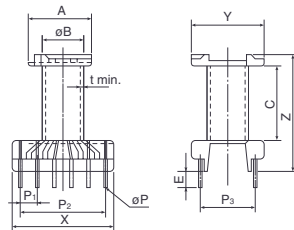

Bobbins	Type	A	ϕB	C	E	X	Y	Z	t(min)
ERB28-P1210-F	1	20.8	12.35	16.3	4.5	24.7	23	26.3	0.9
ERB28L-P1212-F	1	20.8	12.275	22.2	4.5	29.7	23	34.7	0.875
ERB35-P1212-F	1	23.5	13.8	18.3	4	30	28	31.8	0.9
ERB42A-P1214-F	1	31.4	20	27.4	4.5	34	35	41.4	1

[mm]

Numbering Systems

ERB 28L - P12 12 - F
 ① ② ③ ④

- ① Core size
- ② P12: Vertical type
- ③ Number of pins
- ④ Material : Phenol resin



FPQ Type Ferrite Cores

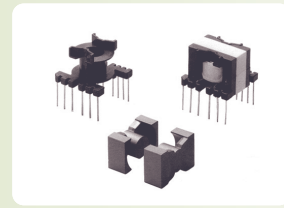

Cores	Bobbins	Dimensions[mm] A
FPQ2016	PQB2016-P1214	23.2
FPQ2020		
FPQ2620		
FPQ2625	PQB2625-P1212 PQB2625-P1212-F	29.5
FPQ3220		
FPQ3230	PQB3230-P1212-F	34.3
FPQ3535	PQB3535-P1212-F	39.3
FPQ4040		

Shape and Dimensions

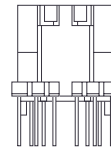
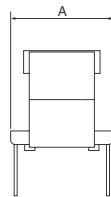

- All specifications in this catalog and production status of products are subject to change without notice. Prior to the purchase, please contact NEC TOKIN for updated product data.
- Please request for a specification sheet for detailed product data prior to the purchase.
- Before using the product in this catalog, please read "Precautions" and other safety precautions listed in the printed version catalog.

FPQ-Type Cores

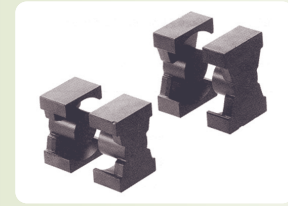

Cores	C_1 (mm ⁻¹)	Ae (mm ²)	ℓ e (mm)	Ve (mm ³)	Acp (mm ²)	Acw (mm ²)	AL(nH) BH1,BH2	Weight (g)
FPQ2016	0.58	65	37.3	2420	61	47.4	3800±25%	13.0
FPQ2020	0.70	65	45.3	2920	61	65.8	3150±25%	15.0
FPQ2620	0.36	124	44.5	5510	113	60.4	6000±25%	31.0
FPQ2625	0.44	123	53.7	6620	113	84.5	5000±25%	36.0
FPQ3220	0.31	157	48.9	76980	142	80.8	7310±25%	42.0
FPQ3230	0.44	156	68.4	10700	142	149.6	5150±25%	55.0
FPQ3535	0.46	172	79.6	13700	162	220.6	4900±25%	73.0
FPQ4040	0.49	189	92.9	17600	174	326	4700±25%	95.0

Shape and Dimensions

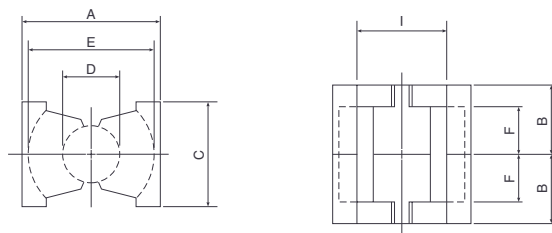

Cores	A	B	C	D	E	F	I (min)
FPQ2016	20.9 ⁺⁰ _{-0.8}	8.2 ⁺⁰ _{-0.2}	14.4 ⁺⁰ _{-0.8}	9.0 ⁺⁰ _{-0.4}	17.6 ^{+0.8} ₋₀	5.0 ^{+0.3} ₋₀	12.0
FPQ2020	20.9 ⁺⁰ _{-0.8}	10.2 ⁺⁰ _{-0.2}	14.4 ⁺⁰ _{-0.8}	9.0 ⁺⁰ _{-0.4}	17.6 ^{+0.8} ₋₀	7.0 ^{+0.3} ₋₀	12.0
FPQ2620	26.95 ⁺⁰ _{-0.9}	10.2 ⁺⁰ _{-0.2}	19.45 ⁺⁰ _{-0.9}	12.2 ⁺⁰ _{-0.4}	22.05 ^{+0.9} ₋₀	5.6 ^{+0.3} ₋₀	15.5
FPQ2625	26.95 ⁺⁰ _{-0.9}	12.5 ⁺⁰ _{-0.25}	19.45 ⁺⁰ _{-0.9}	12.2 ⁺⁰ _{-0.4}	22.05 ^{+0.9} ₋₀	7.9 ^{+0.3} ₋₀	15.5
FPQ3220	32.5 ⁺⁰ _{-1.0}	10.4 ⁺⁰ _{-0.25}	22.5 ⁺⁰ _{-1.0}	13.7 ⁺⁰ _{-0.5}	27.0 ^{+1.0} ₋₀	5.6 ^{+0.3} ₋₀	19.0
FPQ3230	32.5 ⁺⁰ _{-1.0}	15.3 ⁺⁰ _{-0.25}	22.5 ⁺⁰ _{-1.0}	13.7 ⁺⁰ _{-0.5}	27.0 ^{+1.0} ₋₀	10.5 ^{+0.3} ₋₀	19.0
FPQ3535	35.7 ⁺⁰ _{-1.2}	17.5 ⁺⁰ _{-0.25}	26.5 ⁺⁰ _{-1.0}	14.6 ⁺⁰ _{-0.5}	31.5 ^{+1.0} ₋₀	12.35 ^{+0.3} ₋₀	23.5
FPQ4040	41.4 ⁺⁰ _{-1.8}	20.0 ⁺⁰ _{-0.25}	28.6 ⁺⁰ _{-1.2}	15.2 ⁺⁰ _{-0.5}	36.4 ^{+1.2} ₋₀	14.6 ^{+0.3} ₋₀	28.0

[mm]

Numbering Systems

FPQ 2016 - BH2

① ②

- ① Core size
- ② Core material



- All specifications in this catalog and production status of products are subject to change without notice. Prior to the purchase, please contact NEC TOKIN for updated product data.
- Please request for a specification sheet for detailed product data prior to the purchase.
- Before using the product in this catalog, please read "Precautions" and other safety precautions listed in the printed version catalog.

FPQ-Type Bobbins

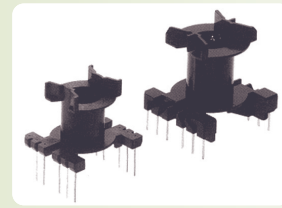

Bobbins	Type	ϕP	P1 (mm)	P2 (mm)	P3 (mm)	P4 (mm)	P5 (mm)	Number of pins	Aw (mm ²)	ℓw (mm)	Weight (g)
PQB2016-P1214	1	0.6	3.81	20.32	20.32	5.08	2.54	14	25.6	44	2.1
PQB2625-P1212-F	2	0.6	3.81	22.86	25.4	7.62	—	12	50.3	56.3	3.5
PQB3230-P1212-F	2	0.8	5.08	27.94	30.48	7.62	—	12	98.1	66.8	6.4
PQB3535-P1212-F	2	0.8	5.08	30.48	35.56	10.16	—	12	159	75.2	8.0

Shape and Dimensions

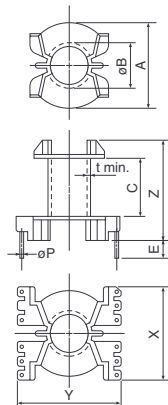

● Pin pitch dimensions

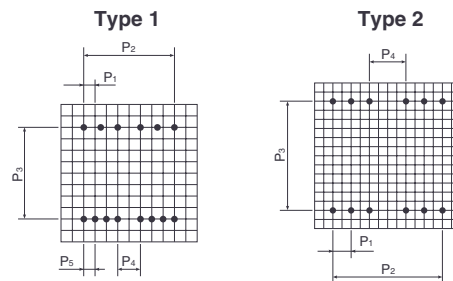

Bobbins	Type	A	ϕB	C	E	X	Y	Z	t(min)
PQB2016-P1214	1	17.2	10.8	8	9.8	23	23	16.7	0.575
PQB2625-P1212-F	2	21.6	14.2	13.6	5	26.5	29.3	27.3	0.7
PQB3230-P1212-F	2	26.6	16	18.5	5	32	34	33.5	0.95
PQB3535-P1212-F	2	31.1	16.8	22.3	6.5	35	39	37.9	0.875

[mm]

Numbering System

PQB 2016 -P12 14 -F

① ② ③ ④

- ① Core size
- ② P12: Vertical type
- ③ Number of pins
- ④ Material : Phenol resin



- All specifications in this catalog and production status of products are subject to change without notice. Prior to the purchase, please contact NEC TOKIN for updated product data.
- Please request for a specification sheet for detailed product data prior to the purchase.
- Before using the product in this catalog, please read "Precautions" and other safety precautions listed in the printed version catalog.

FQK Type Ferrite Cores

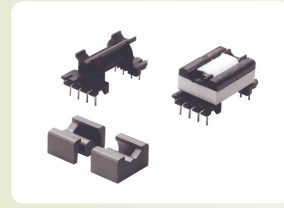

Cores	Bobbins	Dimensions[mm]	
		A	B
FQK1623	QKB1623-P1108-F	34.15	13.25
FQK2522	QKB2522-P1108-F	31.7	19.75
FQK2532	QKB2532-P1108-F	40.4	19.75

Shape and Dimensions



[mm]



- All specifications in this catalog and production status of products are subject to change without notice. Prior to the purchase, please contact NEC TOKIN for updated product data.
- Please request for a specification sheet for detailed product data prior to the purchase.
- Before using the product in this catalog, please read "Precautions" and other safety precautions listed in the printed version catalog.

FQK-Type Cores

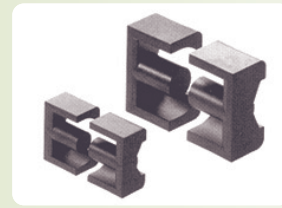

Cores	C _i (mm ⁻¹)	A _e (mm ²)	ℓ _e (mm)	V _e (mm ³)	A _{cp} (mm ²)	A _{cw} (mm ²)	AL(nH) BH1,BH2	Weight (g)
FQK1623	1.41	31.3	44.1	1377	24.6	31.9	1700±25%	9.6
FQK2522	0.72	67.9	49.0	3327	58.1	48.0	3200±25%	21.0
FQK2532	0.91	70.3	64.0	4498	58.1	73.8	2500±25%	30.0

Shape and Dimensions

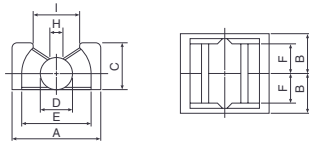

Cores	A	B	C	D	E	F	H	l (min)
FQK1623	16.5±0.3	11.8 ⁺⁰ _{-0.2}	8.7±0.2	5.8 ⁺⁰ _{-0.2}	12.5±0.3	8.6 ^{+0.25} ₋₀	3.0	9.0±0.5
FQK2522	25.0±0.4	11.3 ⁺⁰ _{-0.2}	12.9±0.3	8.8 ⁺⁰ _{-0.4}	19.0±0.3	8.05 ^{+0.3} ₋₀	3.0	13.5±0.5
FQK2532	25.0±0.4	16.0 ⁺⁰ _{-0.2}	12.9±0.3	8.8 ⁺⁰ _{-0.4}	19.0±0.3	11.9 ^{+0.3} ₋₀	3.0	13.5±0.5

[mm]

Numbering System

FQK 1623 - BH2

① ②

- ① Core size
- ② Core material



- All specifications in this catalog and production status of products are subject to change without notice. Prior to the purchase, please contact NEC TOKIN for updated product data.
- Please request for a specification sheet for detailed product data prior to the purchase.
- Before using the product in this catalog, please read "Precautions" and other safety precautions listed in the printed version catalog.

FQK-Type Bobbins

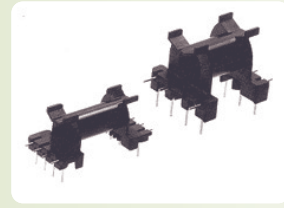

Bobbins	ϕP	P1 (mm)	P2 (mm)	P3 (mm)	Number of pins	Aw (mm ²)	ℓ w (mm)	Weight (g)
QKB1623-P1108-F	0.6	3.81	11.43	25.4	8	31.9	30.9	1.7
QKB2522-P1108-F	0.8	6.35	19.05	20.32	8	47.8	44.6	2.8
QKB2532-P1108-F	0.8	6.35	19.05	27.94	8	73.9	44.6	3.3

Shape and Dimensions

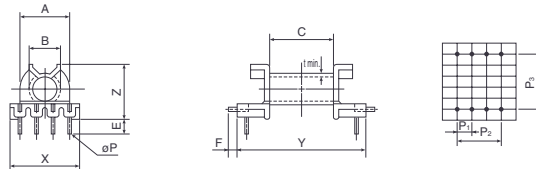

Bobbins	A	ϕB	C	E	F	X	Y	Z	t (min)
QKB1623-P1108-F	11.9	7.8	15.2	4	1.95	16.5	30.1	13.1	0.75
QKB2522-P1108-F	17.6	10.825	14.1	5	3.5	25	34.5	19.55	0.725
QKB2532-P1108-F	17.6	10.825	21.8	5	3.35	25	33.4	19.55	0.725

[mm]

Numbering System

QKB 1623 - P11 08 - F
 ① ② ③ ④

- ① Core size
- ② P11:Horizontal type
- ③ Number of pins
- ④ Material: Phenol resin



- All specifications in this catalog and production status of products are subject to change without notice. Prior to the purchase, please contact NEC TOKIN for updated product data.
- Please request for a specification sheet for detailed product data prior to the purchase.
- Before using the product in this catalog, please read "Precautions" and other safety precautions listed in the printed version catalog.

FEP-Type Cores



Cores	JIS	C_1 (mm^{-1})	A_e (mm^2)	ℓ_e (mm)	V_e (mm^3)	A_{cp} (mm^2)	A_{cw} (mm^2)	AL (nH)	Weight (g)
FEP7	EP7	1.52	10	15.7	160	9	11	>550 (BH2) >1100 (5H) >3000 (7H) >4000 (10H) >5200 (12H)	1.4
FEP10	EP10	1.7	11	19.2	220	9	23	>850 (BH2) >1080 (5H) >2800 (7H) >3600 (10H) >4000 (12H)	2.8
FEP13	EP13	1.24	20	24.2	470	15	26	>1250 (BH2) >1700 (5H) >3800 (7H) >5000 (10H) >6000 (12H)	5.1
FEP17	EP17	0.84	34	28.5	970	25	36	>2500 (5H) >5800 (7H) >8000 (10H) >9600 (12H)	11.8
FEP20	EP20	0.51	78	39.8	3120	60	55	>4200 (5H) >9600 (7H) >13500 (10H) >16200 (12H)	27.6

Shape and Dimensions

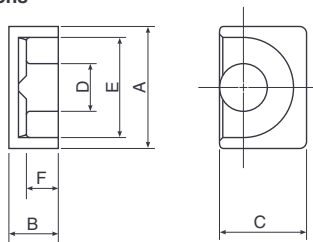

Cores	JIS	A	B	C	D	E	F
FEP7	EP7	9.2±0.2	3.75 ⁺⁰ _{-0.1}	6.5 ⁺⁰ _{-0.3}	3.4 ⁺⁰ _{-0.2}	7.4±0.2	2.5 ^{+0.2} ₋₀
FEP10	EP10	11.5±0.3	5.2 ⁺⁰ _{-0.2}	7.85 ⁺⁰ _{-0.4}	3.45 ⁺⁰ _{-0.3}	9.4±0.2	3.6 ^{+0.2} ₋₀
FEP13	EP13	12.5±0.3	6.5 ⁺⁰ _{-0.15}	9.0 ⁺⁰ _{-0.4}	4.5 ⁺⁰ _{-0.3}	10.0±0.3	4.5 ^{+0.2} ₋₀
FEP17	EP17	18.0±0.4	8.5 ⁺⁰ _{-0.2}	11.25 ⁺⁰ _{-0.5}	5.85 ⁺⁰ _{-0.35}	12.0±0.4	5.5 ^{+0.3} ₋₀
FEP20	EP20	24.0±0.5	10.8 ⁺⁰ _{-0.2}	15.3 ⁺⁰ _{-0.7}	9.0 ⁺⁰ _{-0.5}	16.5±0.4	7.0 ^{+0.3} ₋₀

[mm]

Numbering System

FEP 10 - 12H
① ②

- ① Core size
- ② Core material



- All specifications in this catalog and production status of products are subject to change without notice. Prior to the purchase, please contact NEC TOKIN for updated product data.
- Please request for a specification sheet for detailed product data prior to the purchase.
- Before using the product in this catalog, please read "Precautions" and other safety precautions listed in the printed version catalog.

P-Type Cores



Cores	C ₁	A _e (mm ²)	ℓ _e (mm ²)	V _e (mm ³)	AL (nH)	Weight (g)	Bobbin Item
FP0905-I-22	1.25	10.0	12.5	125	1100nom. (BH2) 1570±25% (5H)	0.8	PB0905-1
FP1107-I-22	1.00	15.9	15.9	252	1700nom. (BH2) 2320±25% (5H)	1.6	PB1107-1 PB1107-2
FP1408-I-22	0.80	25.0	20.0	500	2520nom. (BH2) 3000±25% (5H) 11300±30% (12H)	2.9	PB1408-1 PB1408-2 PB1408-P124
FP1811-I-22	0.60	43.2	25.9	1120	3450nom. (BH2) 4500±25% (5H) 12000±30% (12H)	6.4	PB1811-1 PB1811-2 PB1811-P126
FP2213-I-22	0.50	63.3	31.6	2000	5900±25% (5H)	12.4	PB2213-1 PB2213-2 PB2213-P126
FP2616-I-22	0.40	93.0	37.2	3460	7800±25% (5H)	21.6	PB2616-1 PB2616-2 PB2616-P126
FP3019-I-22	0.33	136	44.8	6100	9800±25% (5H)	36.2	PB3019-1 PB3019-2 PB3019-P126
FP3622-I-22	0.26	202	52.4	10600	13300±25% (5H)	60	PB3622-1 PB3622-2

Shape and Dimesions

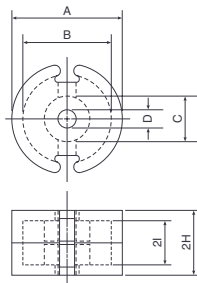

Cores	A	B	C	D	2H	2l
FP0905-I-22	9.30 ⁺⁰ _{-0.35}	7.50 ^{+0.35} ₋₀	3.90 ⁺⁰ _{-0.20}	2.00 ^{+0.15} ₋₀	5.40 ⁺⁰ _{-0.30}	3.60 ^{+0.50} ₋₀
FP1107-I-22	11.30 ⁺⁰ _{-0.40}	9.00 ^{+0.40} ₋₀	4.70 ⁺⁰ _{-0.20}	2.00 ^{+0.15} ₋₀	6.60 ⁺⁰ _{-0.30}	4.40 ^{+0.30} ₋₀
FP1408-I-22	14.10 ⁺⁰ _{-0.40}	11.60 ^{+0.40} ₋₀	6.00 ⁺⁰ _{-0.20}	3.00 ^{+0.15} ₋₀	8.40 ⁺⁰ _{-0.40}	5.60 ^{+0.50} ₋₀
FP1811-I-22	18.00 ⁺⁰ _{-0.50}	14.90 ^{+0.50} ₋₀	7.60 ⁺⁰ _{-0.30}	3.00 ^{+0.15} ₋₀	10.60 ⁺⁰ _{-0.40}	7.20 ^{+0.60} ₋₀
FP2213-I-22	22.00 ⁺⁰ _{-0.60}	17.90 ^{+0.60} ₋₀	9.40 ⁺⁰ _{-0.40}	4.40 ^{+0.20} ₋₀	13.60 ⁺⁰ _{-0.40}	9.20 ^{+0.60} ₋₀
FP2616-I-22	26.00 ⁺⁰ _{-1.00}	21.20 ^{+0.80} ₋₀	11.50 ⁺⁰ _{-0.40}	5.50 ^{+0.20} ₋₀	16.30 ⁺⁰ _{-0.40}	11.00 ^{+0.40} ₋₀
FP3019-I-22	30.50 ⁺⁰ _{-1.00}	25.00 ^{+0.80} ₋₀	13.50 ⁺⁰ _{-0.40}	5.50 ^{+0.20} ₋₀	19.00 ⁺⁰ _{-0.40}	13.00 ^{+0.40} ₋₀
FP3622-I-22	36.00 ⁺⁰ _{-1.00}	29.90 ^{+0.80} ₋₀	16.20 ⁺⁰ _{-0.40}	5.50 ^{+0.20} ₋₀	22.00 ⁺⁰ _{-0.40}	14.60 ^{+0.40} ₋₀

[mm]

Numbering System

FP1811 I- 2 2 5H

① ② ③

- ① Core size
- ② Number of slots of cores
- ③ Cores material



- All specifications in this catalog and production status of products are subject to change without notice. Prior to the purchase, please contact NEC TOKIN for updated product data.
- Please request for a specification sheet for detailed product data prior to the purchase.
- Before using the product in this catalog, please read "Precautions" and other safety precautions listed in the printed version catalog.

RM-Type Cores



Cores	Type	C_i (mm ⁻¹)	A_e (mm ²)	l_e (mm)	V_e (mm ³)	AL (nH)	Weight (g)
FQ0910-RM4	3	1.62	1.40	22.7	318	1240±25% (5H) 3100±25% (7H) 4100±30% (10H) 4950±30% (12H)*	1.7
FQ1210-RM5	1	1.02	21.0	21.4	450	1350min (BH2) 2220±25% (5H) 5800±25% (7H) 8800±30% (10H) 9100±30% (12H)*	2.8
FQ1412-RM6	2	0.86	31.0	27.0	837	1720min (BH2) 3300±25% (5H) 6000±25% (7H) 8500±30% (10H) 11500±30%(12H)*	4.6
FQ1916-RM8	2	0.67	52.0	35.1	1825	2200min (BH2) 4300±25% (5H) 9800±25% (7H) 13800±30%(10H) 15200±30%(12H)*	10.4
FQ2418-RM10	3	0.45	98.0	44.0	4312	6620±25% (5H) 13800±25%(7H) 18800±30%(10H)	23

*1kHz 0.5mA

Shape and Dimensions

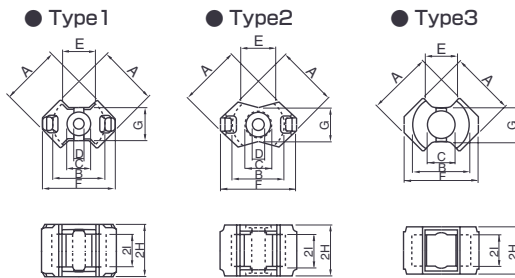

Cores	A	B	C	D	E	F	G	2H	2l
FQ0910-RM4	9.60±0.20	8.15±0.20	3.80±0.10		5.80	10.80±0.20	4.45±0.15	10.40±0.10	7.20±0.25
FQ1210-RM5	12.05±0.25	10.40±0.20	4.80±0.10	2.05±0.05	6.00	14.65±0.25	6.60±0.20	10.40±0.10	6.50±0.20
FQ1412-RM6	14.40±0.30	12.65±0.25	6.30±0.10	3.05±0.05	8.40	17.60±0.30	8.10±0.10	12.40±0.10	8.20±0.20
FQ1916-RM8	19.35±0.35	17.30±0.30	8.40±0.15	4.50±0.10	9.80	22.75±0.45	(11.0)	16.40±0.10	11.00±0.20
FQ2418-RM10	24.15±0.55	21.65±0.45	10.70±0.20		11.30	27.85±0.65	13.25±0.25	18.60±0.10	12.70±0.30

[mm]

Numbering System

FQ1412-RM6 - 12H

① ②

① Core size
② Core material



- All specifications in this catalog and production status of products are subject to change without notice. Prior to the purchase, please contact NEC TOKIN for updated product data.
- Please request for a specification sheet for detailed product data prior to the purchase.
- Before using the product in this catalog, please read "Precautions" and other safety precautions listed in the printed version catalog.

FUU-Type Cores

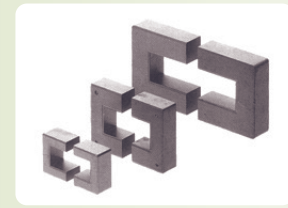

Cores	C_1 (mm ⁻¹)	A_e (mm ²)	l_e (mm)	V_e (mm ³)	AL(nH) 5H	Weight (g)
FUU9	4.30	7.9	34.2	271	800±30%	1.4
FUU10.5	3.07	13.0	40.0	520	1800±30%	2.7
FUU16	2.22	23.3	51.7	1202	2000±30%	6.5
FUU17	2.88	26.2	75.5	1977	1600±30%	10.3
FUU20	2.31	35.9	83.1	2980	2200±30%	15.4

Shape and Dimensions

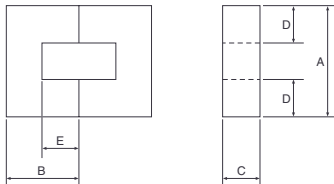

Cores	A	B	C	D	E
FUU9	9.8±0.2	7.1±0.1	2.7±0.2	2.8±0.1	4.2±0.2
FUU10.5	10.5±0.2	7.9±0.1	5.0±0.2	2.6±0.15	5.3±0.2
FUU16	17.0±0.3	10.1±0.1	5.0±0.2	5.0±0.15	5.85±0.2
FUU17	17.0±0.3	15.6±0.3	6.0±0.2	4.7 ^{+0.1} _{-0.2}	11.8±0.3
FUU20	20.0±0.4	18.0 ^{+0.3} _{-0.2}	6.0±0.2	6.0 ^{+0.1} _{-0.2}	12.0±0.2

[mm]

Numbering System

FUU 10.5 - 5H
① ②

- ① Core size
- ② Core material



- All specifications in this catalog and production status of products are subject to change without notice. Prior to the purchase, please contact NEC TOKIN for updated product data.
- Please request for a specification sheet for detailed product data prior to the purchase.
- Before using the product in this catalog, please read "Precautions" and other safety precautions listed in the printed version catalog.

Toroidal Cores

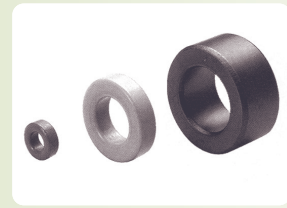

● Standard material characteristics (See of page 12.)

Cores	C _i (mm ⁻¹)	A _e (mm ²)	ℓ _e (mm)	V _e (mm ³)	AL(nH)			
					5H	7H	10H	12H
FR8.6/4.5/3.2	3.07	6.3	19.2	120	1580±30%	2500±30%	—	4600±35%
FR10/5/5	1.85	11.4	20.9	238	2470±30%	4800±30%	—	7300±35%
FR11/6/3	3.49	7.2	25.1	181	—	2260±30%	—	4200±35%
FR12.7/7.6/6	2.07	14.8	30.5	450	2400±30%	3900±30%	—	6600±35%
FR14/7/5	1.84	16.6	30.5	506	2650±30%	4660±30%	6360±30%	7700±35%
FR16/7/4	1.92	16.8	32.3	543	2470±30%	4820±30%	6300±30%	7200±35%
FR19/10/10	0.96	43.1	41.6	1794	5970±30%	9520±30%	11000±30%	14000±35%
FR20/10/5	1.83	23.8	43.6	1037	2640±30%	4740±30%	6400±30%	7400±35%
FR25/15/12	1.03	58.5	60.2	3521	5730±30%	8500±30%	11500±30%	13000±35%
FR38/19/13	0.72	116	82.8	9584	8570±30%	12100±30%	13700±30%	—
FR47/27/15	0.76	145	110	16064	8170±30%	11500±30%	—	—

Note: These can be coated with melamine resin.

Shape and Dimensions

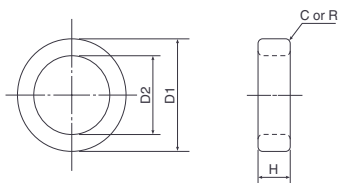

Cores	D1	D2	H	C or R
FR8.6/4.5/3.2	8.6±0.3	4.5±0.3	3.2±0.3	0.3
FR10/5/5	9.9±0.4	4.7±0.3	4.6±0.3	0.3
FR11/6/3	11.0±0.4	6.0±0.3	3.0±0.3	0.3
FR12.7/7.6/6	12.7±0.3	7.6±0.3	6.0±0.3	0.5
FR14/7/5	14.0±0.4	7.0±0.4	5.0±0.3	0.5
FR16/7/4	16.0±0.4	7.0±0.4	4.0±0.3	0.5
FR19/10/10	18.5±0.5	9.8±0.5	10.3±0.4	0.5
FR20/10/5	20.0±0.5	10.0±0.5	5.0±0.3	0.5
FR25/15/12	25.0±0.5	15.0±0.5	12.0±0.3	0.5
FR38/19/13	38.1±0.8	19.0±0.5	12.7±0.5	1.0
FR47/27/15	47.0±0.8	27.0±0.5	15.0±0.5	1.0

[mm]

Numbering System

FR 8.6 / 4.5 / 3.2 - 5H

① ② ③ ④

- ① Outside diameter
- ② Inside diameter
- ③ Thickness
- ④ Core material



- All specifications in this catalog and production status of products are subject to change without notice. Prior to the purchase, please contact NEC TOKIN for updated product data.
- Please request for a specification sheet for detailed product data prior to the purchase.
- Before using the product in this catalog, please read "Precautions" and other safety precautions listed in the printed version catalog.



- All specifications in this catalog and production status of products are subject to change without notice. Prior to the purchase, please contact NEC TOKIN for updated product data.
- Please request for a specification sheet for detailed product data prior to the purchase.
- Before using the product in this catalog, please read "Precautions" and other safety precautions listed in the printed version catalog.

BH2 Compound Technical Data



- All specifications in this catalog and production status of products are subject to change without notice. Prior to the purchase, please contact NEC TOKIN for updated product data.
- Please request for a specification sheet for detailed product data prior to the purchase.
- Before using the product in this catalog, please read "Precautions" and other safety precautions listed in the printed version catalog.

FEI 12.5

AL* (nH)	Core constant C_1 (mm ⁻¹)	Effective cross-sectional area Ae (mm ²)	Effective magnetic path length ℓ_e (mm)	Effective volume Ve (mm ³)	Cross-sectional center leg area Acp (mm ²)	Cross-sectional winding area of core Acw (mm ²)	Weight (g/set)
1400±25%	1.42	15.2	21.6	328	12.8	17	1.9

*1kHz 1mA ø0.2 100T(Air Gap 0)

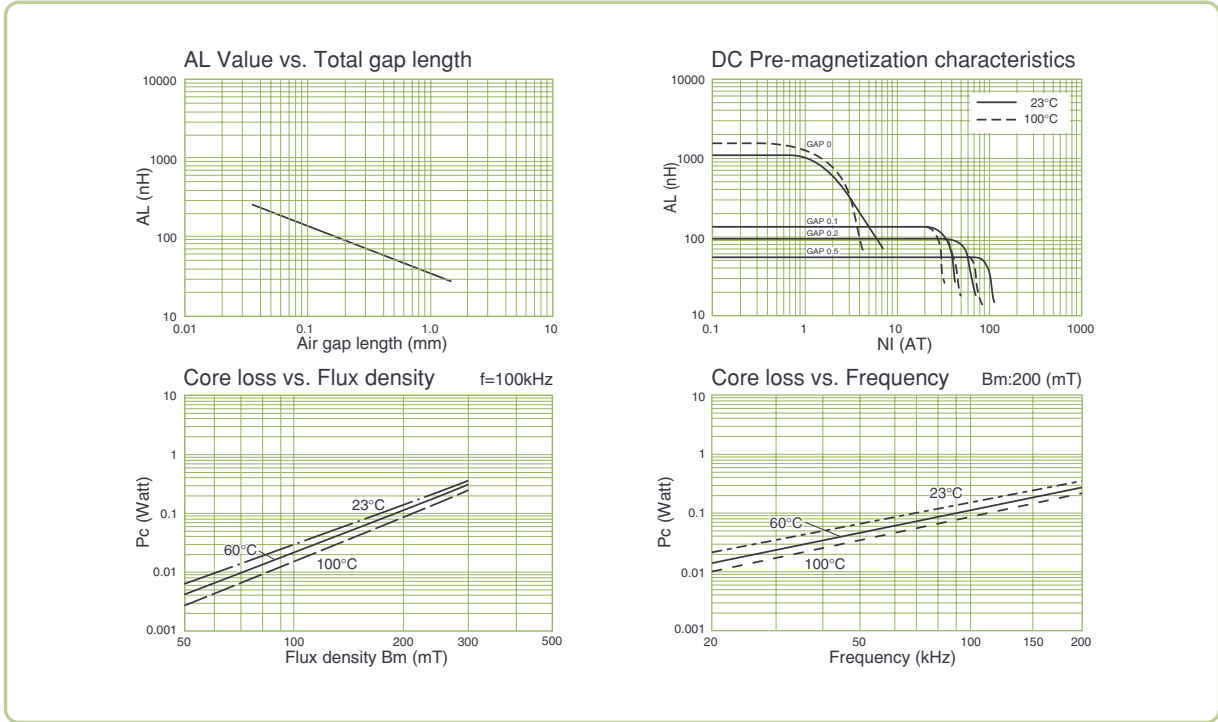
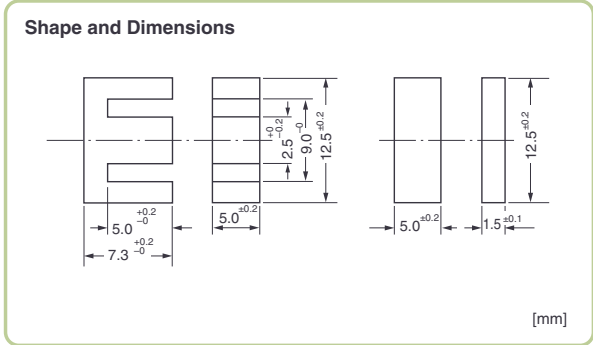

- All specifications in this catalog and production status of products are subject to change without notice. Prior to the purchase, please contact NEC TOKIN for updated product data.
- Please request for a specification sheet for detailed product data prior to the purchase.
- Before using the product in this catalog, please read "Precautions" and other safety precautions listed in the printed version catalog.

FEI 16

AL* (nH)	Core constant C_1 (mm ⁻¹)	Effective cross-sectional area Ae (mm ²)	Effective magnetic path length l_e (mm)	Effective volume Ve (mm ³)	Cross-sectional center leg area Acp (mm ²)	Cross-sectional winding area of core Acw (mm ²)	Weight (g/set)
1200±25%	1.79	19.4	34.6	670	19.2	40	3.2

*1kHz 1mA ø0.35 100T(Air Gap 0)

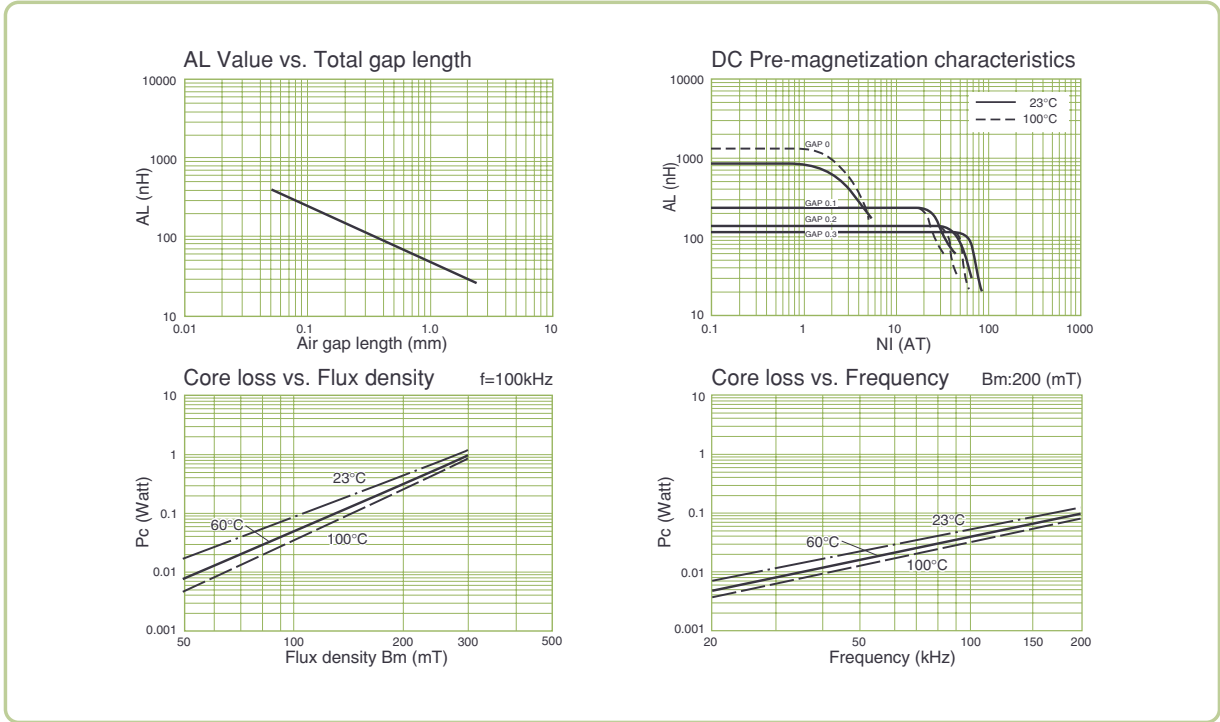
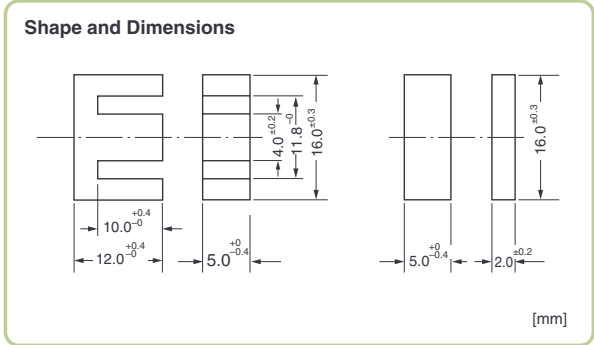

- All specifications in this catalog and production status of products are subject to change without notice. Prior to the purchase, please contact NEC TOKIN for updated product data.
- Please request for a specification sheet for detailed product data prior to the purchase.
- Before using the product in this catalog, please read "Precautions" and other safety precautions listed in the printed version catalog.

FEI 19

AL* (nH)	Core constant C_p (mm ⁻¹)	Effective cross-sectional area A_e (mm ²)	Effective magnetic path length ℓ_e (mm)	Effective volume V_e (mm ³)	Cross-sectional center leg area A_{cp} (mm ²)	Cross-sectional winding area of core A_{cw} (mm ²)	Weight (g/set)
1300±25%	1.74	22.7	39.8	910	22.5	57	4.4

*1kHz 1mA ø0.35 100T(Air Gap 0)

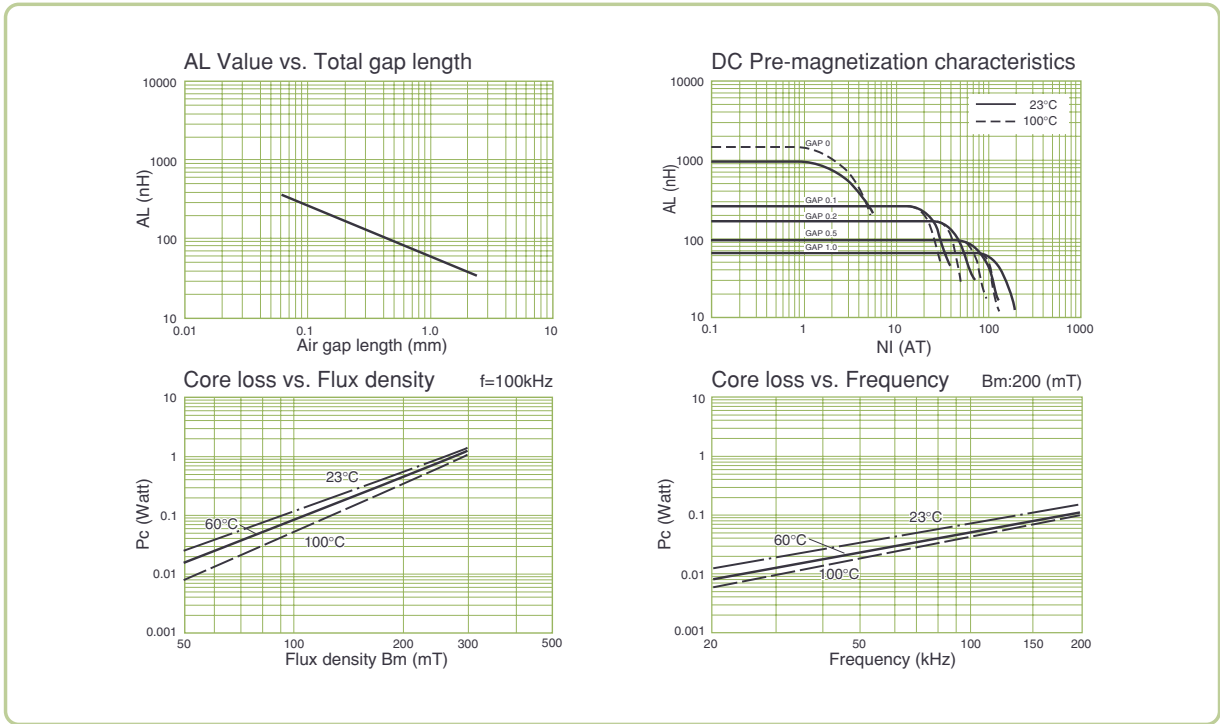
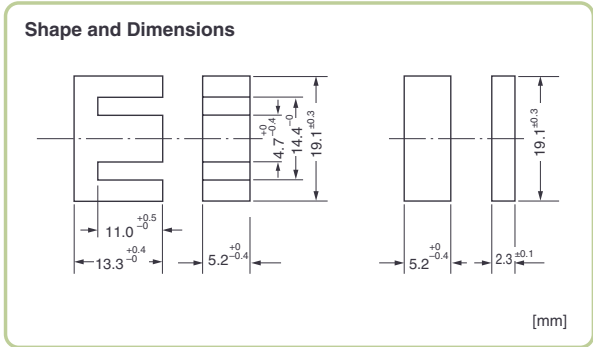

- All specifications in this catalog and production status of products are subject to change without notice. Prior to the purchase, please contact NEC TOKIN for updated product data.
- Please request for a specification sheet for detailed product data prior to the purchase.
- Before using the product in this catalog, please read "Precautions" and other safety precautions listed in the printed version catalog.

FEI 22

AL* (nH)	Core constant C_i (mm ⁻¹)	Effective cross-sectional area A_e (mm ²)	Effective magnetic path length l_e (mm)	Effective volume V_e (mm ³)	Cross-sectional center leg area A_{cp} (mm ²)	Cross-sectional winding area of core A_{cw} (mm ²)	Weight (g/set)
2400±25%	0.95	41.7	39.3	1639	33.1	40	8.8

*1kHz 1mA ø0.35 100T(Air Gap 0)

Shape and Dimensions

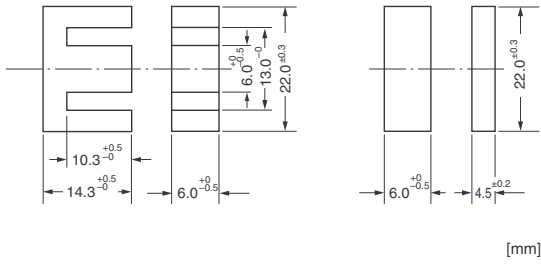

[mm]

AL Value vs. Total gap length

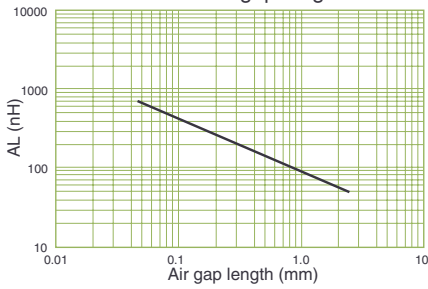

DC Pre-magnetization characteristics

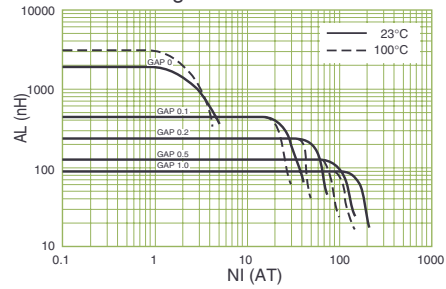

Core loss vs. Flux density f=100kHz

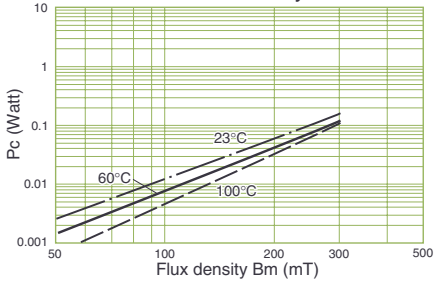

Core loss vs. Frequency Bm:200 (mT)

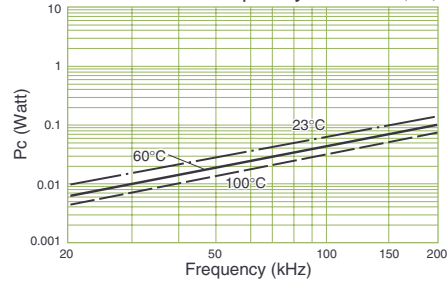

- All specifications in this catalog and production status of products are subject to change without notice. Prior to the purchase, please contact NEC TOKIN for updated product data.
- Please request for a specification sheet for detailed product data prior to the purchase.
- Before using the product in this catalog, please read "Precautions" and other safety precautions listed in the printed version catalog.

FEI 22S

AL*	Core constant C_p	Effective cross-sectional area A_e	Effective magnetic path length ℓ_e	Effective volume V_e	Cross-sectional center leg area A_{cp}	Cross-sectional winding area of core A_{cw}	Weight
(nH)	(mm ⁻¹)	(mm ²)	(mm)	(mm ³)	(mm ²)	(mm ²)	(g/set)
2000±25%	116	36.2	42.1	1525	33.1	57	7.7

*1kHz 1mA ϕ 0.35 100T(Air Gap 0)

Shape and Dimensions

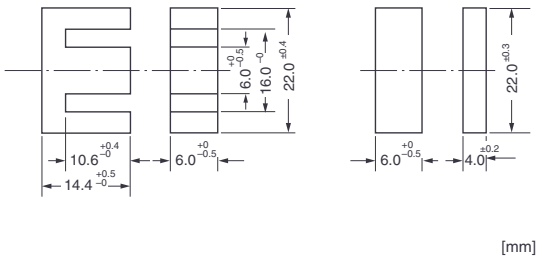

AL Value vs. Total gap length

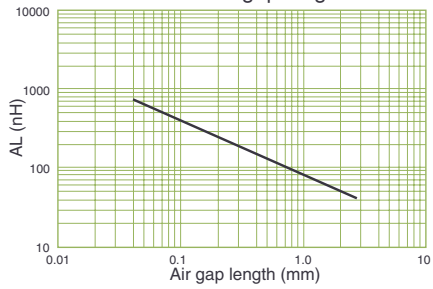

DC Pre-magnetization characteristics

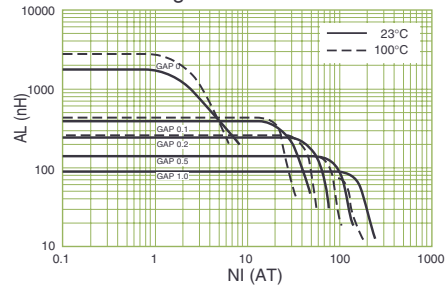

Core loss vs. Flux density f=100kHz

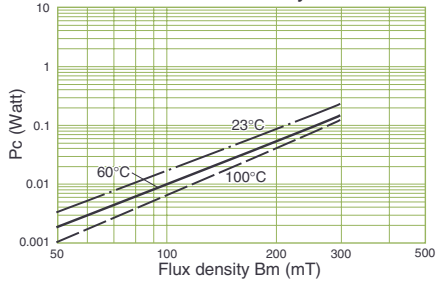

Core loss vs. Frequency Bm:200 (mT)

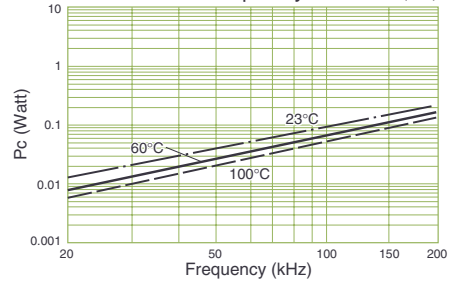

- All specifications in this catalog and production status of products are subject to change without notice. Prior to the purchase, please contact NEC TOKIN for updated product data.
- Please request for a specification sheet for detailed product data prior to the purchase.
- Before using the product in this catalog, please read "Precautions" and other safety precautions listed in the printed version catalog.

FEI 25

AL* (nH)	Core constant C_i (mm ⁻¹)	Effective cross-sectional area A_e (mm ²)	Effective magnetic path length l_e (mm)	Effective volume V_e (mm ³)	Cross-sectional center leg area A_{cp} (mm ²)	Cross-sectional winding area of core A_{cw} (mm ²)	Weight (g/set)
2000±25%	1.14	41.2	47.0	1934	43.9	99	11.0

*1kHz 1mA ø0.35 100T(Air Gap 0)

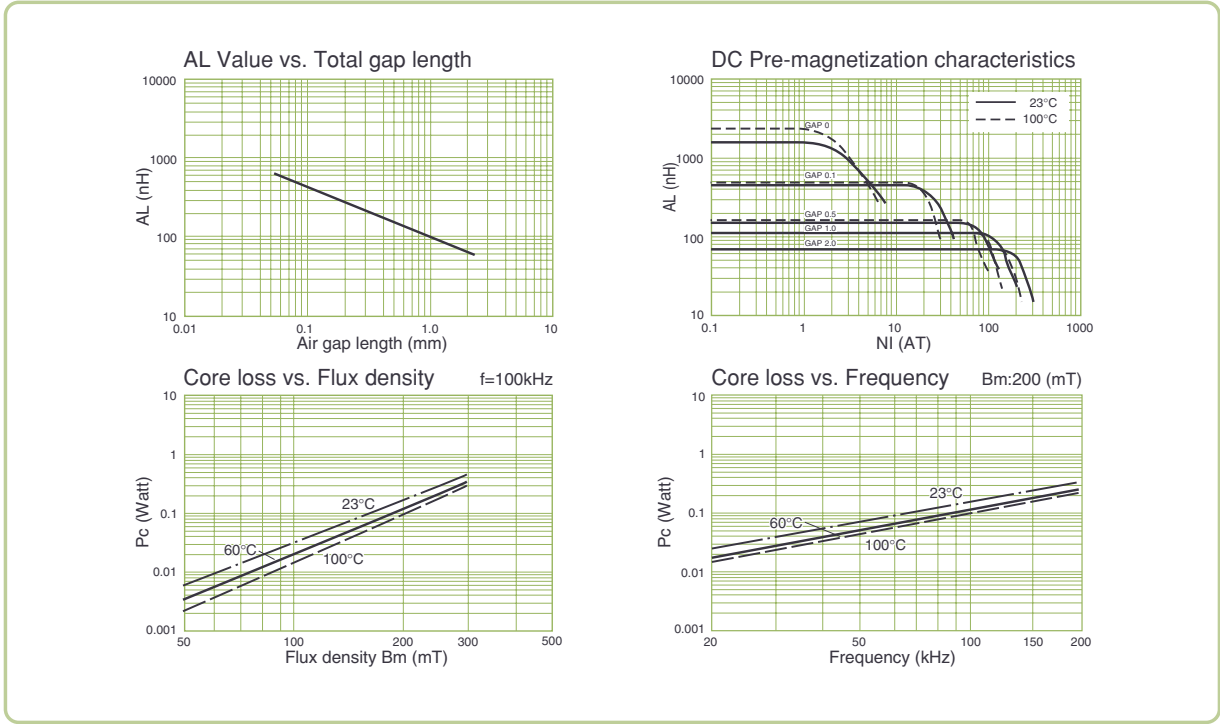
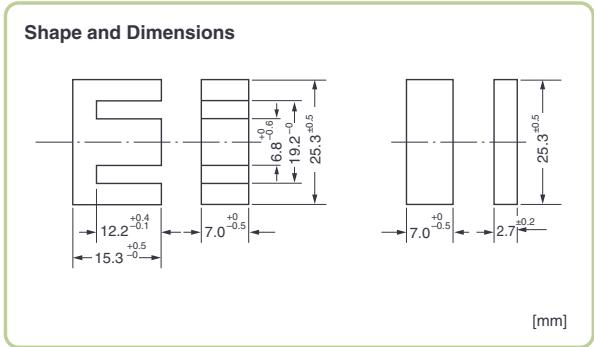

- All specifications in this catalog and production status of products are subject to change without notice. Prior to the purchase, please contact NEC TOKIN for updated product data.
- Please request for a specification sheet for detailed product data prior to the purchase.
- Before using the product in this catalog, please read "Precautions" and other safety precautions listed in the printed version catalog.

FEI 28

AL* (nH)	Core constant C_p (mm ⁻¹)	Effective cross-sectional area A_e (mm ²)	Effective magnetic path length ℓ_e (mm)	Effective volume V_e (mm ³)	Cross-sectional center leg area A_{cp} (mm ²)	Cross-sectional winding area of core A_{cw} (mm ²)	Weight (g/set)
4000±25%	0.57	85.1	48.6	4138	77.0	71	24.0

*1kH 1mA ø0.3 100T(Air Gap 0)

Shape and Dimensions

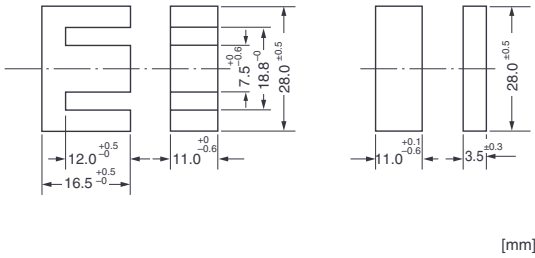

AL Value vs. Total gap length

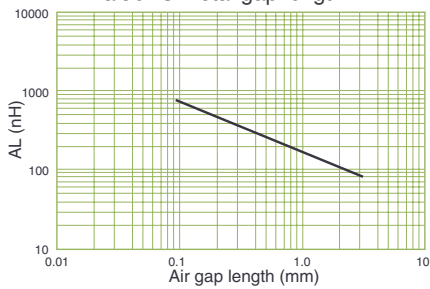

DC Pre-magnetization characteristics

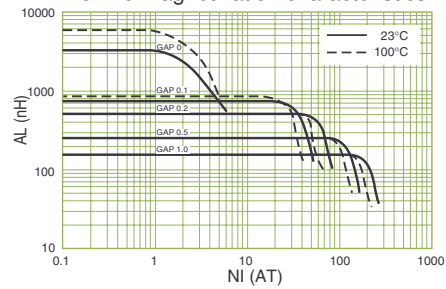

Core loss vs. Flux density f=100kHz

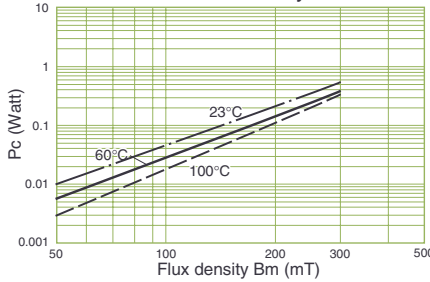

Core loss vs. Frequency Bm:200 (mT)

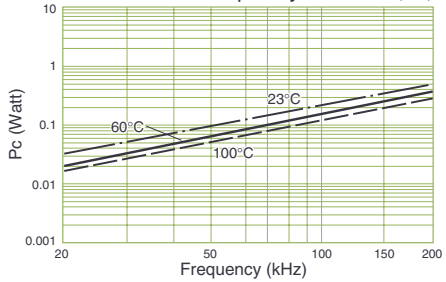

- All specifications in this catalog and production status of products are subject to change without notice. Prior to the purchase, please contact NEC TOKIN for updated product data.
- Please request for a specification sheet for detailed product data prior to the purchase.
- Before using the product in this catalog, please read "Precautions" and other safety precautions listed in the printed version catalog.

FEI 30

AL* (nH)	Core constant C_1 (mm ⁻¹)	Effective cross-sectional area Ae (mm ²)	Effective magnetic path length l_e (mm)	Effective volume Ve (mm ³)	Cross-sectional center leg area Acp (mm ²)	Cross-sectional winding area of core Acw (mm ²)	Weight (g/set)
4700±25%	0.52	111	58.1	6457	114.5	77	35.0

*1kHz 1mA ø0.3 100T(Air Gap 0)

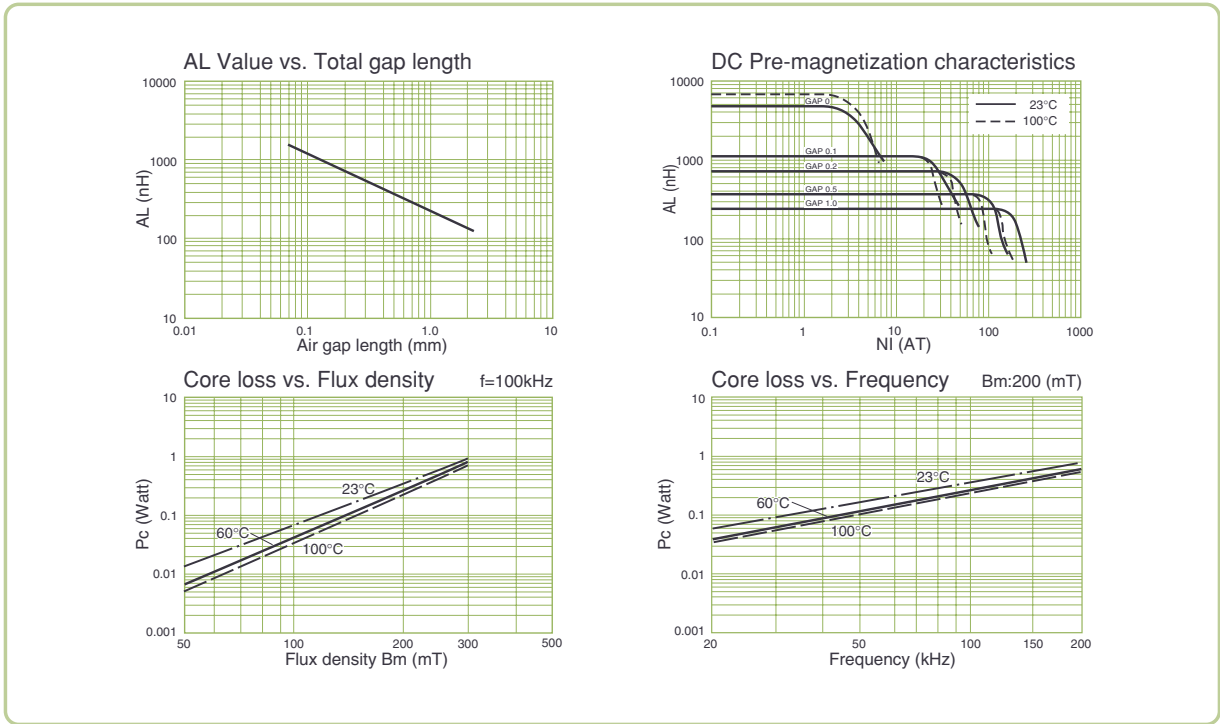
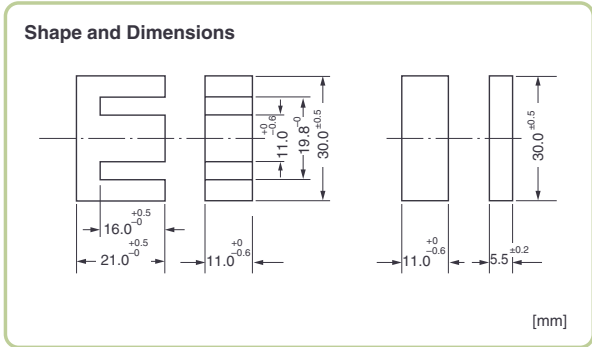

- All specifications in this catalog and production status of products are subject to change without notice. Prior to the purchase, please contact NEC TOKIN for updated product data.
- Please request for a specification sheet for detailed product data prior to the purchase.
- Before using the product in this catalog, please read "Precautions" and other safety precautions listed in the printed version catalog.

FEI 33

AL*	Core constant C_p	Effective cross-sectional area A_e	Effective magnetic path length ℓ_e	Effective volume V_e	Cross-sectional center leg area A_{cp}	Cross-sectional winding area of core A_{cw}	Weight
(nH)	(mm^{-1})	(mm^2)	(mm)	(mm^3)	(mm^2)	(mm^2)	(g/set)
4300±25%	0.57	118.1	66.9	7909	124	136	41.5

*1kHz 1mA ϕ 0.4 100T(Air Gap 0)

Shape and Dimensions

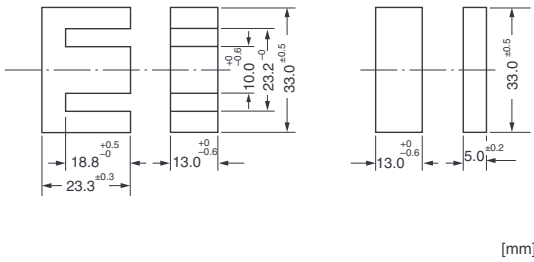

[mm]

AL Value vs. Total gap length

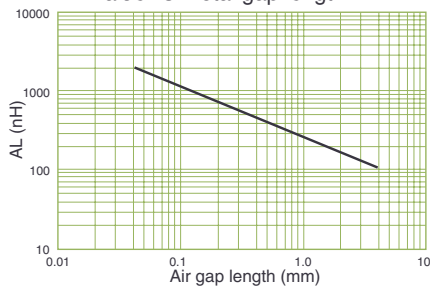

DC Pre-magnetization characteristics

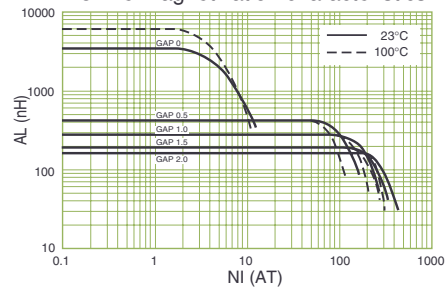

Core loss vs. Flux density $f=100\text{kHz}$

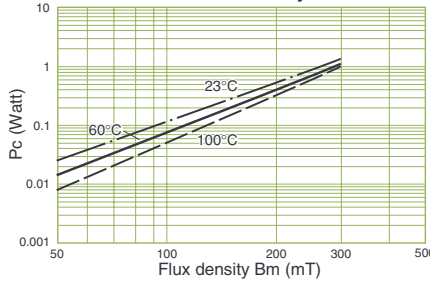

Core loss vs. Frequency $B_m:200\text{ (mT)}$

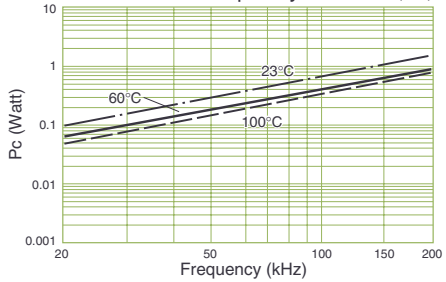

- All specifications in this catalog and production status of products are subject to change without notice. Prior to the purchase, please contact NEC TOKIN for updated product data.
- Please request for a specification sheet for detailed product data prior to the purchase.
- Before using the product in this catalog, please read "Precautions" and other safety precautions listed in the printed version catalog.

FEI 35

AL* (nH)	Core constant C_i (mm ⁻¹)	Effective cross-sectional area A_e (mm ²)	Effective magnetic path length l_e (mm)	Effective volume V_e (mm ³)	Cross-sectional center leg area A_{cp} (mm ²)	Cross-sectional winding area of core A_{cw} (mm ²)	Weight (g/set)
3650±25%	0.68	99.9	67.3	6700	97.0	127	36.2

*1kHz 1mA ø0.5 100T(Air Gap 0)

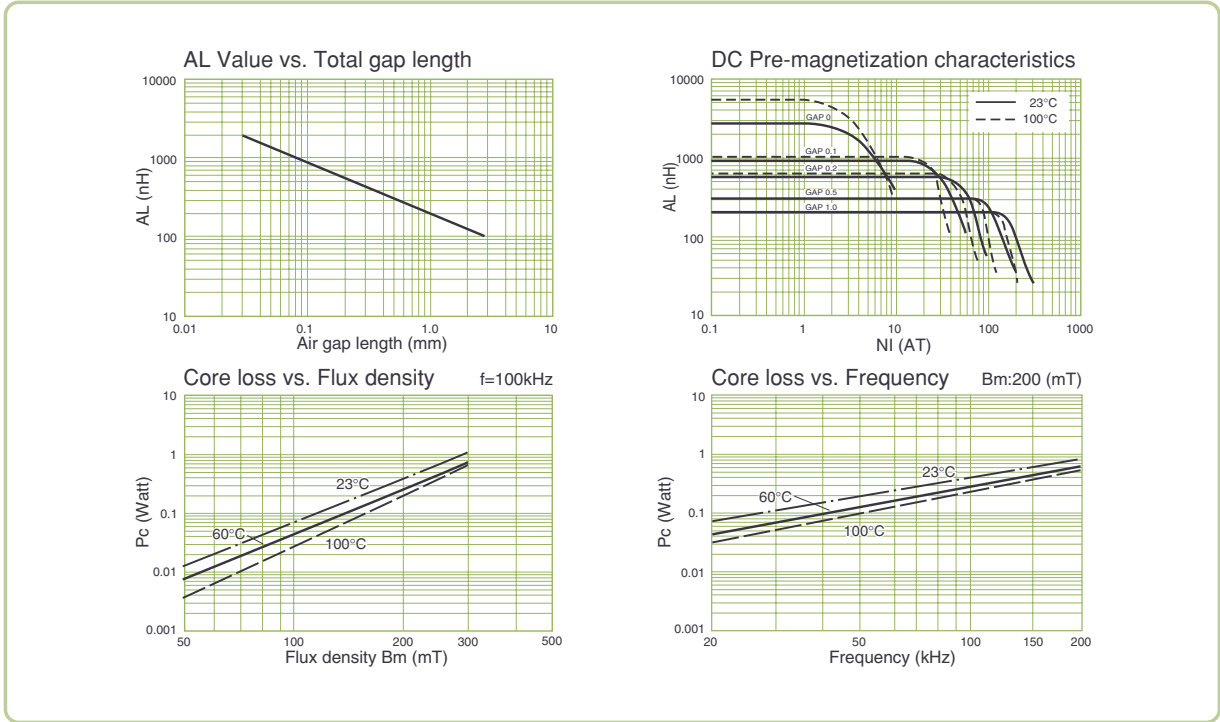
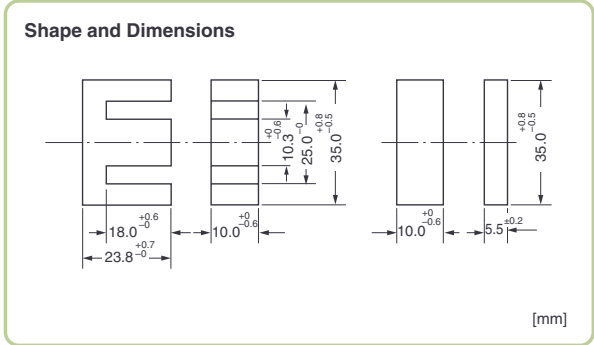

- All specifications in this catalog and production status of products are subject to change without notice. Prior to the purchase, please contact NEC TOKIN for updated product data.
- Please request for a specification sheet for detailed product data prior to the purchase.
- Before using the product in this catalog, please read "Precautions" and other safety precautions listed in the printed version catalog.

FEI 35S

AL* (nH)	Core constant C_p (mm ⁻¹)	Effective cross-sectional area A_e (mm ²)	Effective magnetic path length ℓ_e (mm)	Effective volume V_e (mm ³)	Cross-sectional center leg area A_{cp} (mm ²)	Cross-sectional winding area of core A_{cw} (mm ²)	Weight (g/set)
4400±25%	0.56	120	67.3	8090	117.0	137	41.5

*1kH 1mA ø0.5 100T(Air Gap 0)

Shape and Dimensions

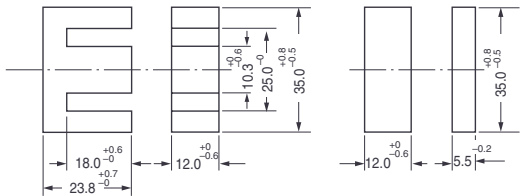

[mm]

AL Value vs. Total gap length

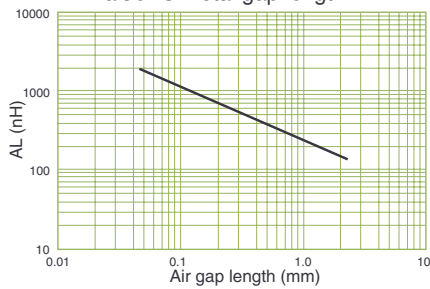

DC Pre-magnetization characteristics

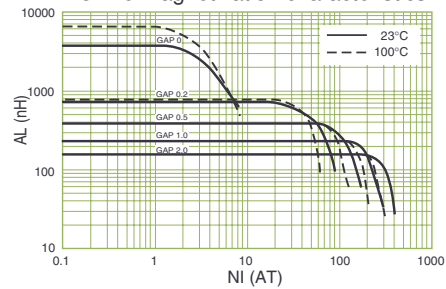

Core loss vs. Flux density $f=100\text{kHz}$

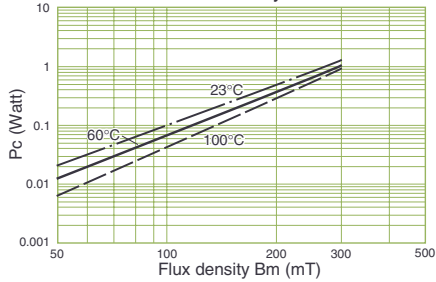

Core loss vs. Frequency $B_m:200\text{ (mT)}$

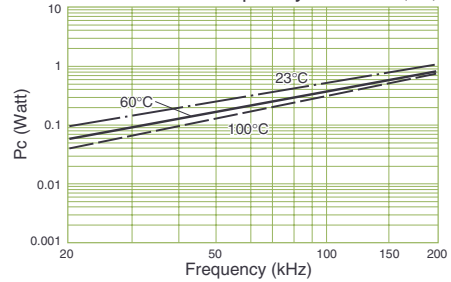

- All specifications in this catalog and production status of products are subject to change without notice. Prior to the purchase, please contact NEC TOKIN for updated product data.
- Please request for a specification sheet for detailed product data prior to the purchase.
- Before using the product in this catalog, please read "Precautions" and other safety precautions listed in the printed version catalog.

FEI 40

AL* (nH)	Core constant C_i (mm ⁻¹)	Effective cross-sectional area A_e (mm ²)	Effective magnetic path length l_e (mm)	Effective volume V_e (mm ³)	Cross-sectional center leg area A_{cp} (mm ²)	Cross-sectional winding area of core A_{cw} (mm ²)	Weight (g/set)
4750±25%	0.52	140	76.8	11378	135.7	163	61.0

*1kHz 1mA ø0.5 100T(Air Gap 0)

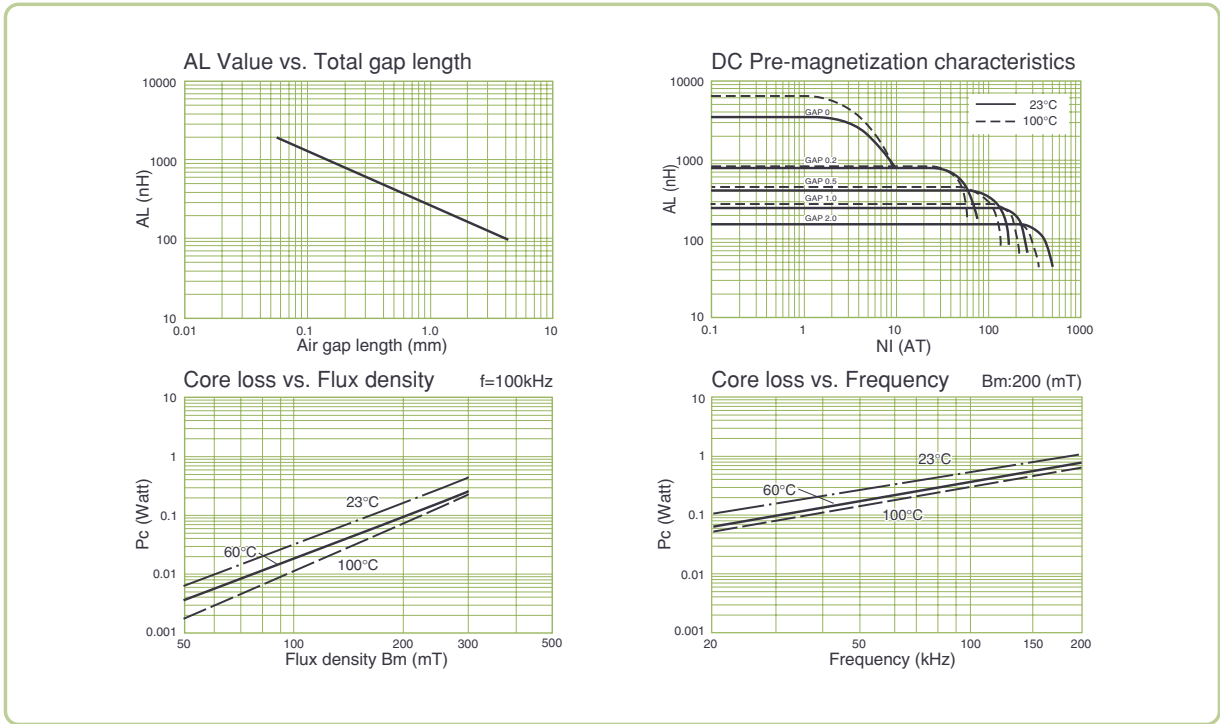
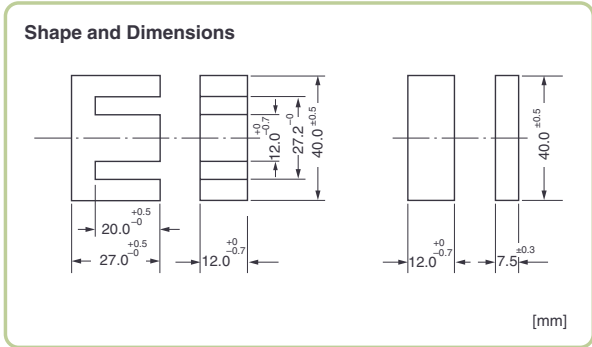

- All specifications in this catalog and production status of products are subject to change without notice. Prior to the purchase, please contact NEC TOKIN for updated product data.
- Please request for a specification sheet for detailed product data prior to the purchase.
- Before using the product in this catalog, please read "Precautions" and other safety precautions listed in the printed version catalog.

FEI 50

AL* (nH)	Core constant C_p (mm^{-1})	Effective cross-sectional area A_e (mm^2)	Effective magnetic path length ℓ_e (mm)	Effective volume V_e (mm^3)	Cross-sectional center leg area A_{cp} (mm^2)	Cross-sectional winding area of core A_{cw} (mm^2)	Weight (g/set)
5950±25%	0.41	230	94.7	2178	213.2	249	110.0

*1kH 1mA ϕ 0.7 100T(Air Gap 0)

Shape and Dimensions

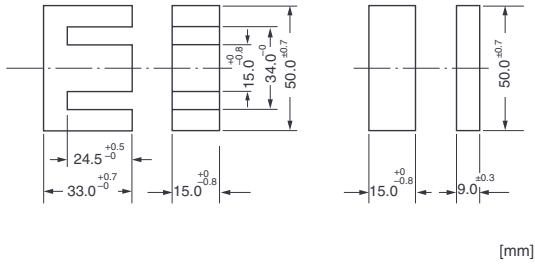

[mm]

AL Value vs. Total gap length

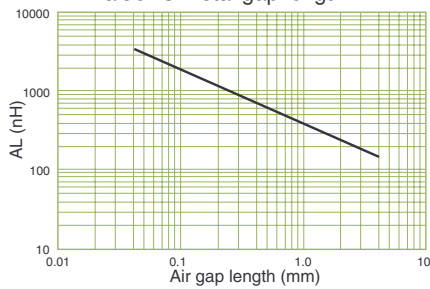

DC Pre-magnetization characteristics

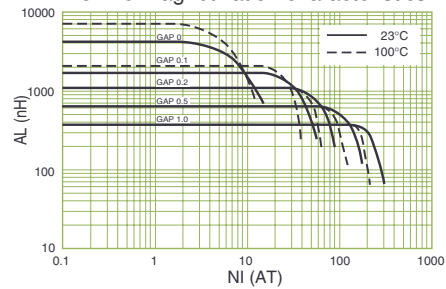

Core loss vs. Flux density $f=100\text{kHz}$

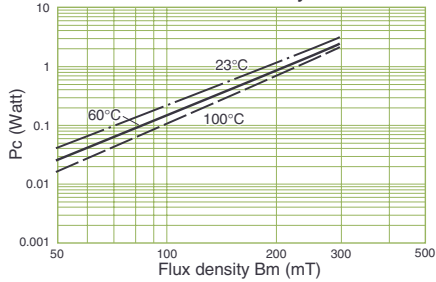

Core loss vs. Frequency $B_m:200\text{ (mT)}$

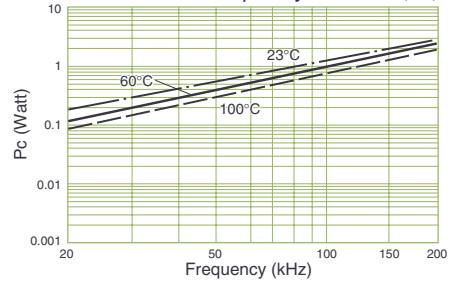

- All specifications in this catalog and production status of products are subject to change without notice. Prior to the purchase, please contact NEC TOKIN for updated product data.
- Please request for a specification sheet for detailed product data prior to the purchase.
- Before using the product in this catalog, please read "Precautions" and other safety precautions listed in the printed version catalog.

FEI 60

AL* (nH)	Core constant C_i (mm ⁻¹)	Effective cross-sectional area A_e (mm ²)	Effective magnetic path length l_e (mm)	Effective volume V_e (mm ³)	Cross-sectional center leg area A_{cp} (mm ²)	Cross-sectional winding area of core A_{cw} (mm ²)	Weight (g/set)
5500±25%	0.44	247	109	27148	243.4	409	140.0

*1kHz 1mA ø0.7 100T(Air Gap 0)

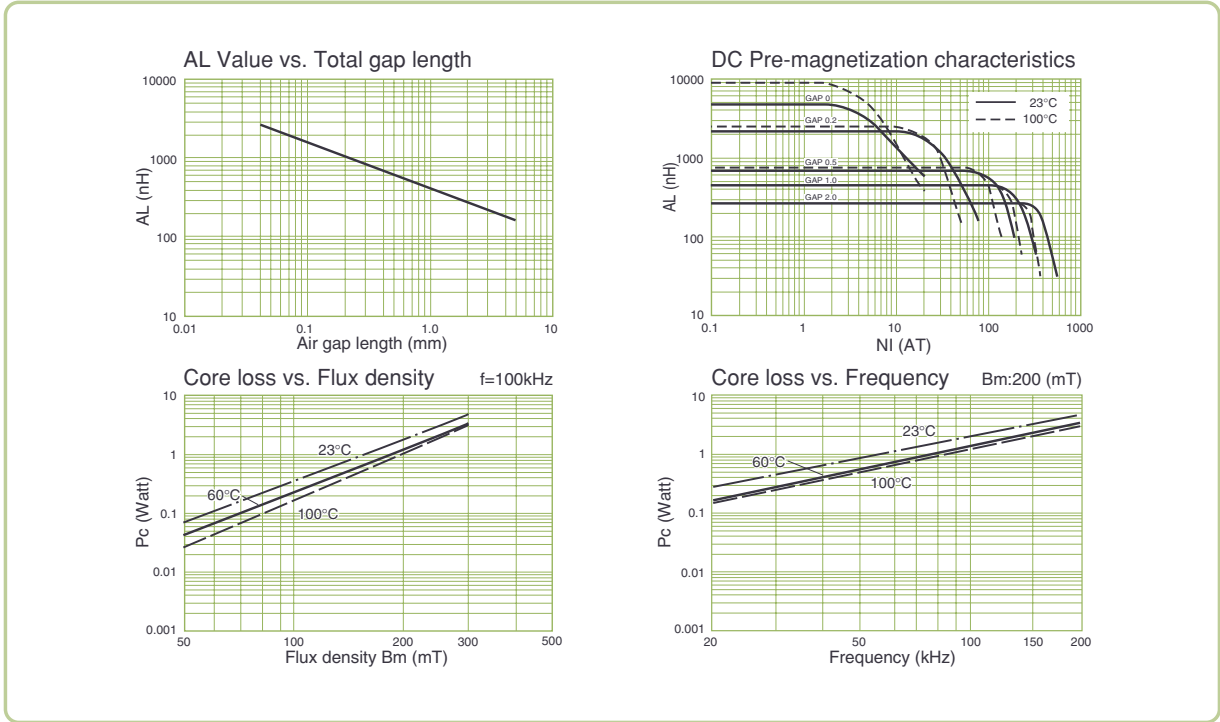
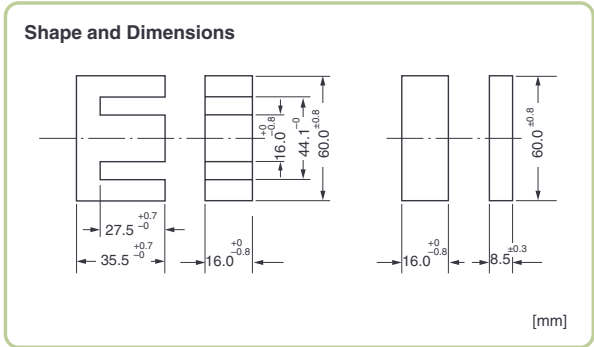

- All specifications in this catalog and production status of products are subject to change without notice. Prior to the purchase, please contact NEC TOKIN for updated product data.
- Please request for a specification sheet for detailed product data prior to the purchase.
- Before using the product in this catalog, please read "Precautions" and other safety precautions listed in the printed version catalog.

FEER 25.5

AL*	Core constant C_p	Effective cross-sectional area A_e	Effective magnetic path length l_e	Effective volume V_e	Cross-sectional center leg area A_{cp}	Cross-sectional winding area of core A_{cw}	Weight
(nH)	(mm ⁻¹)	(mm ²)	(mm)	(mm ³)	(mm ²)	(mm ²)	(g/set)
2050±25%	1.16	43.2	50.0	2157	44.2	80.3	10.8

*1kHz 1mA ø0.5 100T(Air Gap 0)

Shape and Dimensions

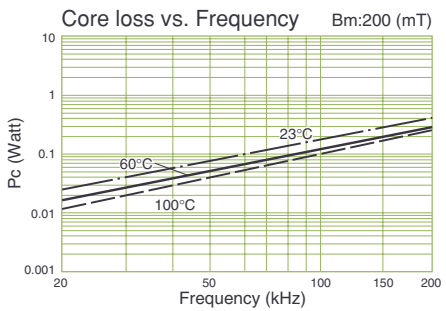
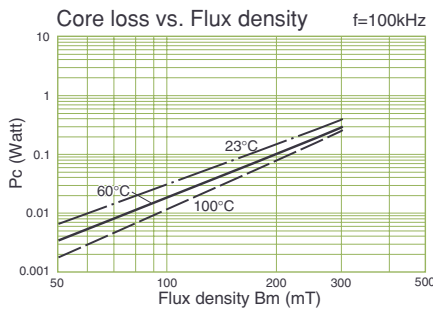
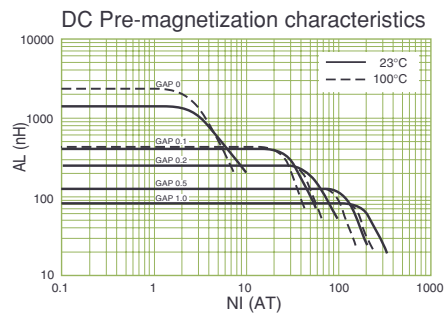
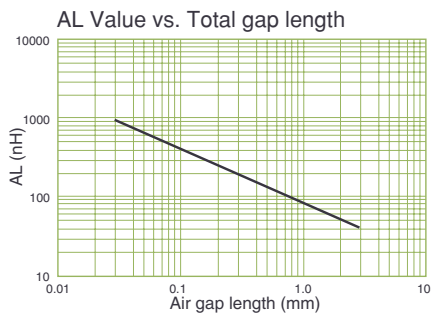
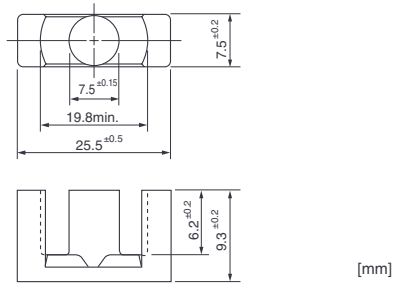

- All specifications in this catalog and production status of products are subject to change without notice. Prior to the purchase, please contact NEC TOKIN for updated product data.
- Please request for a specification sheet for detailed product data prior to the purchase.
- Before using the product in this catalog, please read "Precautions" and other safety precautions listed in the printed version catalog.

FEER 28

AL* (nH)	Core constant C_i (mm ⁻¹)	Effective cross-sectional area A_e (mm ²)	Effective magnetic path length l_e (mm)	Effective volume V_e (mm ³)	Cross-sectional center leg area A_{cp} (mm ²)	Cross-sectional winding area of core A_{cw} (mm ²)	Weight (g/set)
3000±25%	0.78	85.3	66.8	5702	77.0	114.8	28.5

*1kH 1mA ø0.5 100T(Air Gap 0)

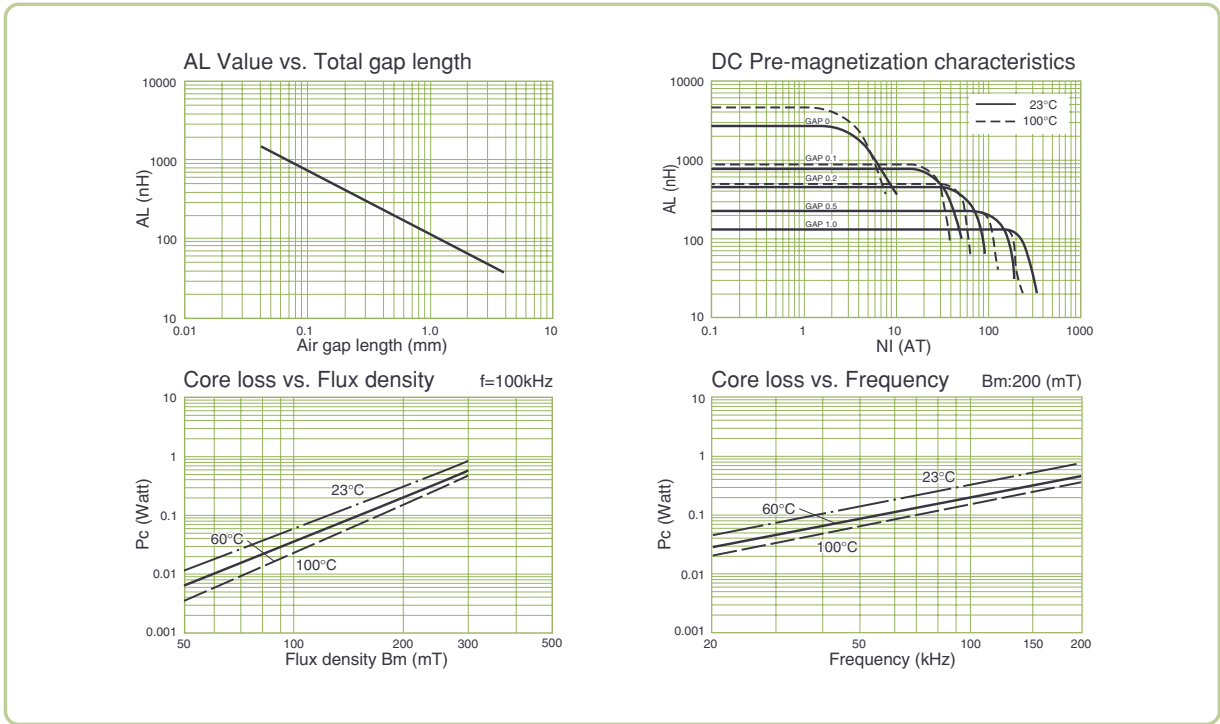
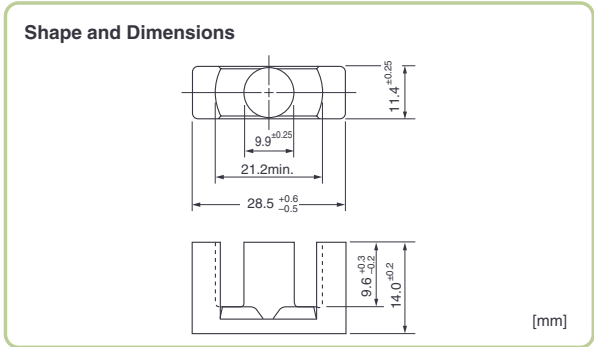

- All specifications in this catalog and production status of products are subject to change without notice. Prior to the purchase, please contact NEC TOKIN for updated product data.
- Please request for a specification sheet for detailed product data prior to the purchase.
- Before using the product in this catalog, please read "Precautions" and other safety precautions listed in the printed version catalog.

FEER 28L

AL*	Core constant C_p	Effective cross-sectional area A_e	Effective magnetic path length l_e	Effective volume V_e	Cross-sectional center leg area A_{cp}	Cross-sectional winding area of core A_{cw}	Weight
(nH)	(mm^{-1})	(mm^2)	(mm)	(mm^3)	(mm^2)	(mm^2)	(g/set)
2540±25%	0.92	87.4	78.3	6635	77.0	149.1	33.2

*1kH 1mA ϕ 0.5 100T(Air Gap 0)

Shape and Dimensions

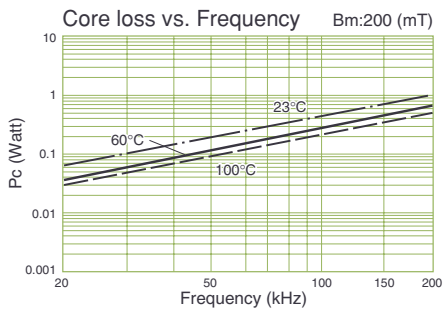
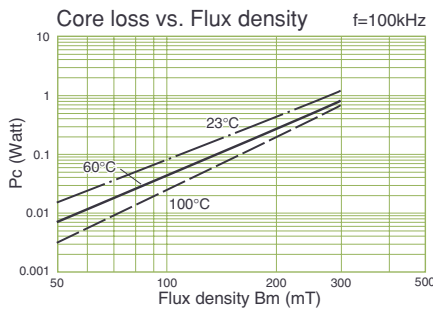
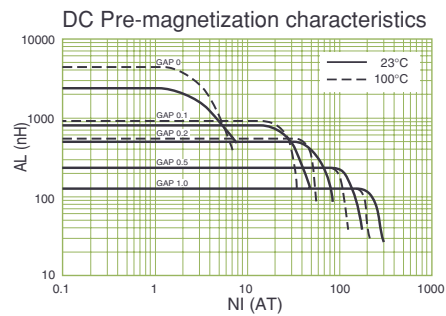
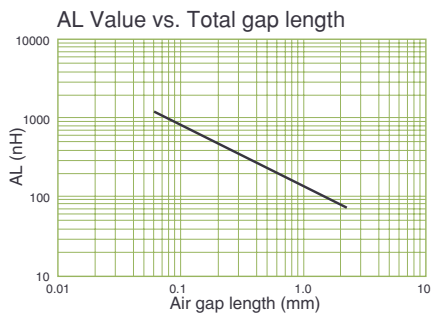
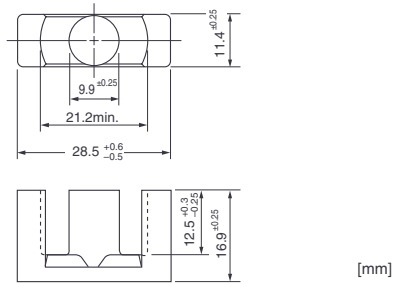

- All specifications in this catalog and production status of products are subject to change without notice. Prior to the purchase, please contact NEC TOKIN for updated product data.
- Please request for a specification sheet for detailed product data prior to the purchase.
- Before using the product in this catalog, please read "Precautions" and other safety precautions listed in the printed version catalog.

FEER 34

AL* (nH)	Core constant C_i (mm ⁻¹)	Effective cross-sectional area A_e (mm ²)	Effective magnetic path length l_e (mm)	Effective volume V_e (mm ³)	Cross-sectional center leg area A_{cp} (mm ²)	Cross-sectional winding area of core A_{cw} (mm ²)	Weight (g/set)
2930±25%	0.86	96.6	83.0	8014	91.6	186.3	41.5

*1kHz 1mA ø0.6 100T(Air Gap 0)

Shape and Dimensions

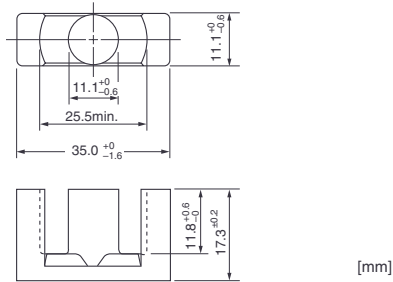

AL Value vs. Total gap length

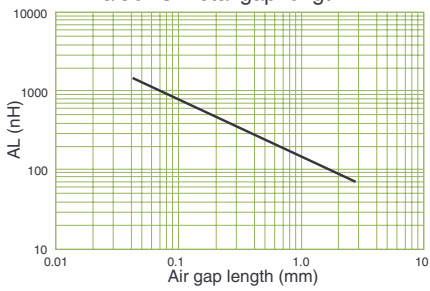

DC Pre-magnetization characteristics

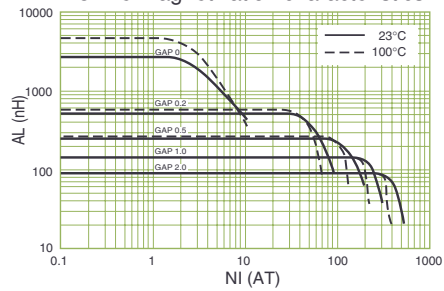

Core loss vs. Flux density f=100kHz

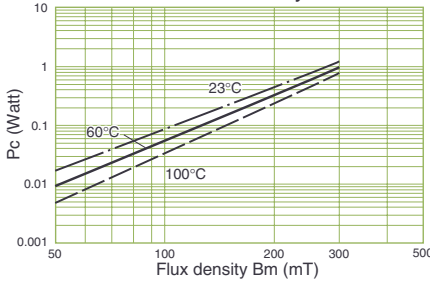

Core loss vs. Frequency Bm:200 (mT)

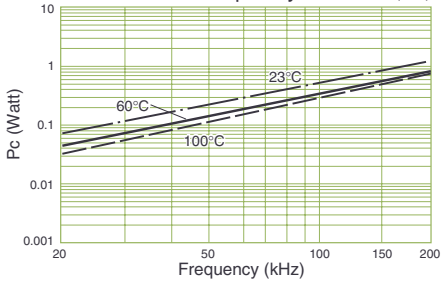

- All specifications in this catalog and production status of products are subject to change without notice. Prior to the purchase, please contact NEC TOKIN for updated product data.
- Please request for a specification sheet for detailed product data prior to the purchase.
- Before using the product in this catalog, please read "Precautions" and other safety precautions listed in the printed version catalog.

FEER 35

AL* (nH)	Core constant C_p (mm ⁻¹)	Effective cross-sectional area A_e (mm ²)	Effective magnetic path length l_e (mm)	Effective volume V_e (mm ³)	Cross-sectional center leg area A_{cp} (mm ²)	Cross-sectional winding area of core A_{cw} (mm ²)	Weight (g/set)
3500±25%	0.72	110.1	79.0	8695	100.3	160.3	45.0

*1kH 1mA ø0.6 100T(Air Gap 0)

Shape and Dimensions

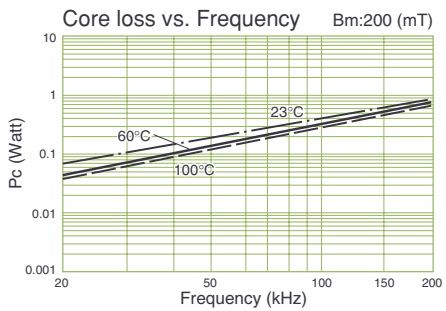
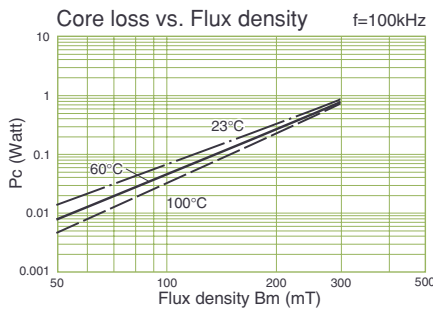
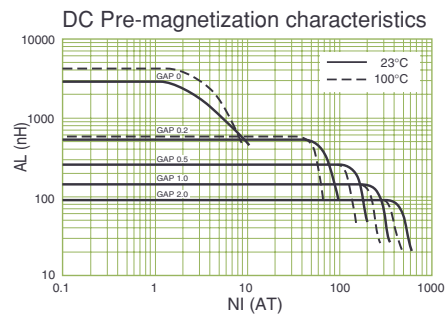
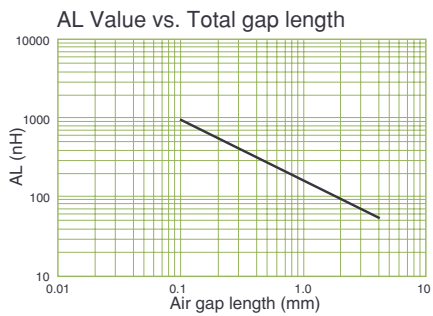
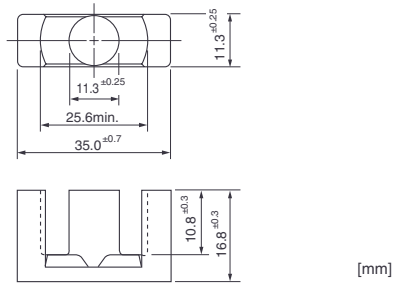

- All specifications in this catalog and production status of products are subject to change without notice. Prior to the purchase, please contact NEC TOKIN for updated product data.
- Please request for a specification sheet for detailed product data prior to the purchase.
- Before using the product in this catalog, please read "Precautions" and other safety precautions listed in the printed version catalog.

FEER 35L

AL* (nH)	Core constant C_i (mm ⁻¹)	Effective cross-sectional area A_e (mm ²)	Effective magnetic path length l_e (mm)	Effective volume V_e (mm ³)	Cross-sectional center leg area A_{cp} (mm ²)	Cross-sectional winding area of core A_{cw} (mm ²)	Weight (g/set)
2900±25%	0.87	108.4	94.5	10248	100.3	220.5	50.7

*1kHz 1mA ø0.7 100T(Air Gap 0)

Shape and Dimensions

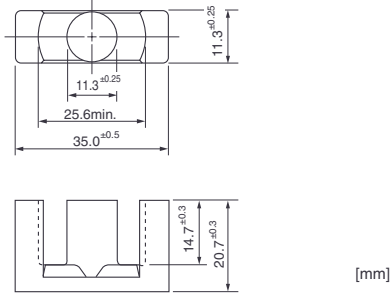

AL Value vs. Total gap length

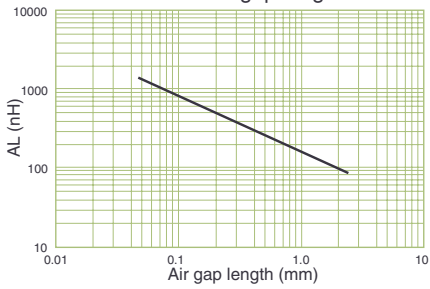

DC Pre-magnetization characteristics

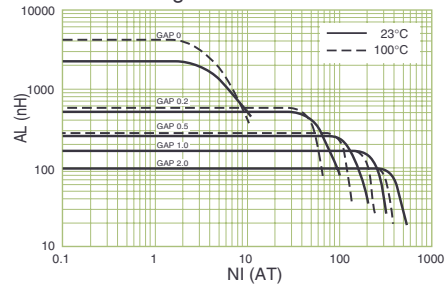

Core loss vs. Flux density $f=100\text{kHz}$

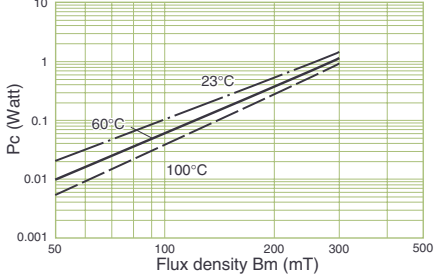

Core loss vs. Frequency $B_m:200\text{ (mT)}$

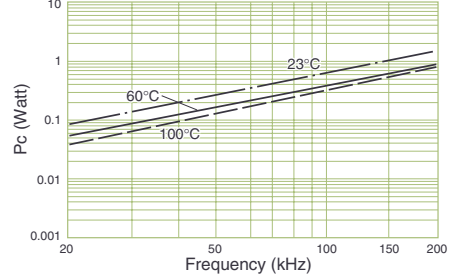

- All specifications in this catalog and production status of products are subject to change without notice. Prior to the purchase, please contact NEC TOKIN for updated product data.
- Please request for a specification sheet for detailed product data prior to the purchase.
- Before using the product in this catalog, please read "Precautions" and other safety precautions listed in the printed version catalog.

FEER 39

AL*	Core constant C_p	Effective cross-sectional area A_e	Effective magnetic path length ℓ_e	Effective volume V_e	Cross-sectional center leg area A_{cp}	Cross-sectional winding area of core A_{cw}	Weight
(nH)	(mm^{-1})	(mm^2)	(mm)	(mm^3)	(mm^2)	(mm^2)	(g/set)
3200±25%	0.79	123.2	97.1	11970	122.7	259.9	60.0

*1kH 1mA ϕ 0.7 100T(Air Gap 0)

Shape and Dimensions

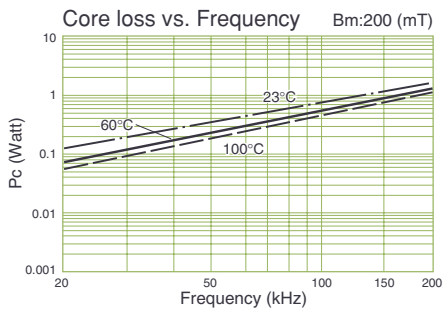
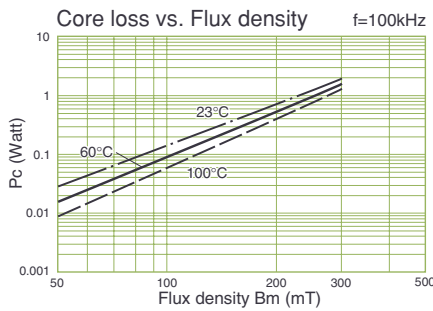
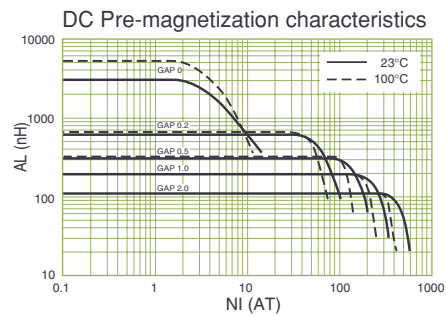
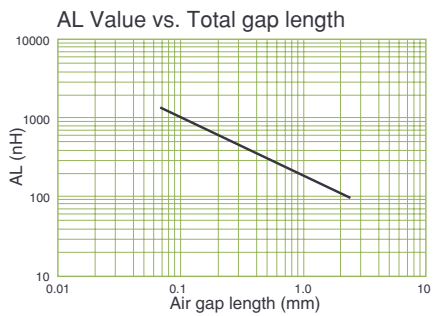
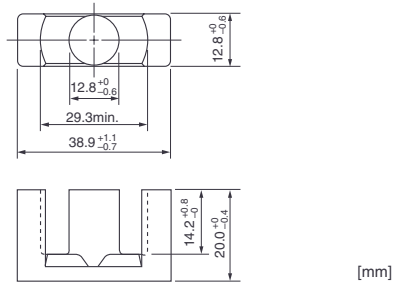

- All specifications in this catalog and production status of products are subject to change without notice. Prior to the purchase, please contact NEC TOKIN for updated product data.
- Please request for a specification sheet for detailed product data prior to the purchase.
- Before using the product in this catalog, please read "Precautions" and other safety precautions listed in the printed version catalog.

FEER 39L

AL* (nH)	Core constant C_i (mm ⁻¹)	Effective cross-sectional area A_e (mm ²)	Effective magnetic path length l_e (mm)	Effective volume V_e (mm ³)	Cross-sectional center leg area A_{cp} (mm ²)	Cross-sectional winding area of core A_{cw} (mm ²)	Weight (g/set)
3150±25%	0.80	131.9	106.1	13993	128.7	280.5	70.0

*1kHz 1mA ø0.7 100T(Air Gap 0)

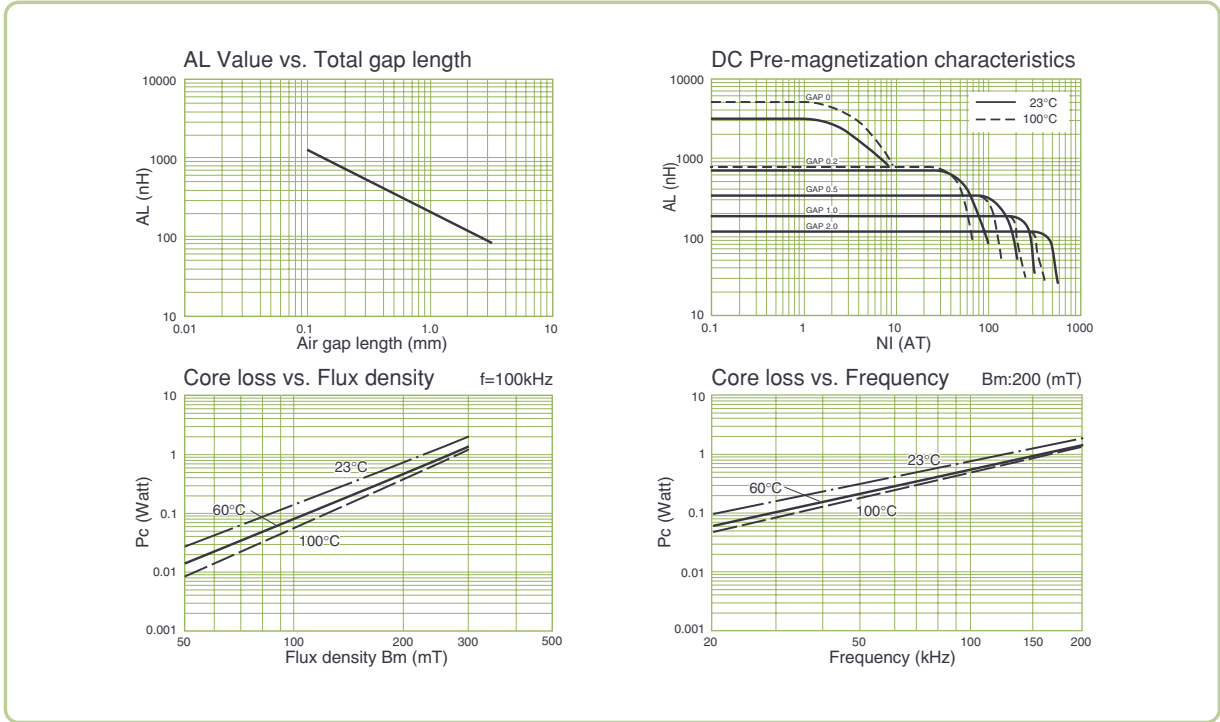
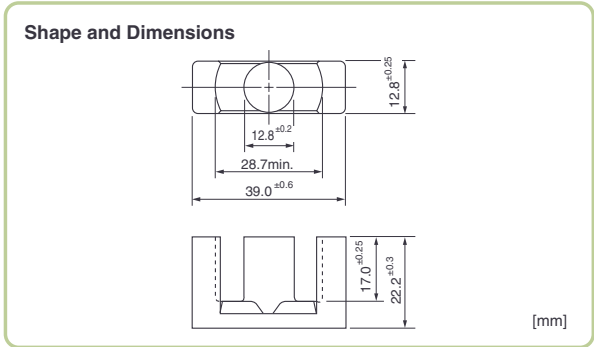

- All specifications in this catalog and production status of products are subject to change without notice. Prior to the purchase, please contact NEC TOKIN for updated product data.
- Please request for a specification sheet for detailed product data prior to the purchase.
- Before using the product in this catalog, please read "Precautions" and other safety precautions listed in the printed version catalog.

FEER 40

AL* (nH)	Core constant C_r (mm ⁻¹)	Effective cross-sectional area A_e (mm ²)	Effective magnetic path length l_e (mm)	Effective volume V_e (mm ³)	Cross-sectional center leg area A_{cp} (mm ²)	Cross-sectional winding area of core A_{cw} (mm ²)	Weight (g/set)
3750±25%	0.67	152.8	102.4	15637	138.9	247.9	78.1

*1kHz 1mA ϕ 0.7 100T(Air Gap 0)

Shape and Dimensions

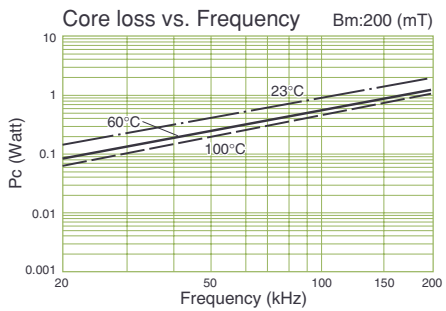
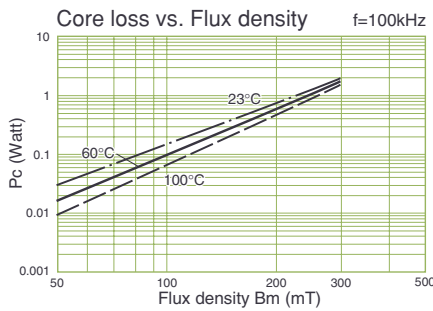
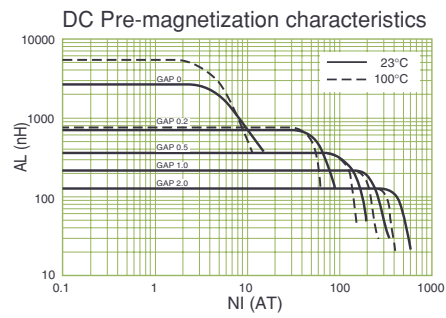
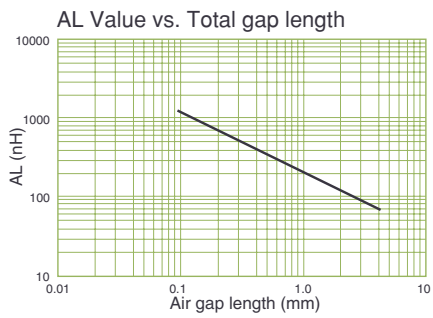
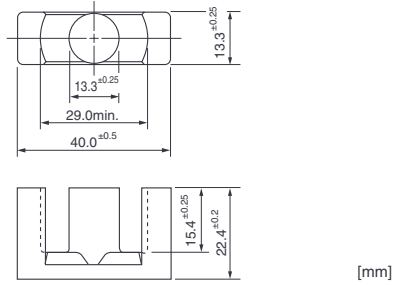

- All specifications in this catalog and production status of products are subject to change without notice. Prior to the purchase, please contact NEC TOKIN for updated product data.
- Please request for a specification sheet for detailed product data prior to the purchase.
- Before using the product in this catalog, please read "Precautions" and other safety precautions listed in the printed version catalog.

FEER 42

AL* (nH)	Core constant C_i (mm ⁻¹)	Effective cross-sectional area A_e (mm ²)	Effective magnetic path length l_e (mm)	Effective volume V_e (mm ³)	Cross-sectional center leg area A_{cp} (mm ²)	Cross-sectional winding area of core A_{cw} (mm ²)	Weight (g/set)
4550±25%	0.56	182.5	101.8	18574	181.5	241.0	86.6

*1kHz 1mA ø0.7 100T(Air Gap 0)

Shape and Dimensions

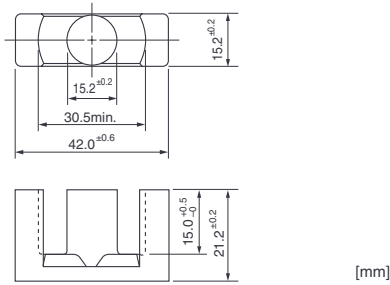

AL Value vs. Total gap length

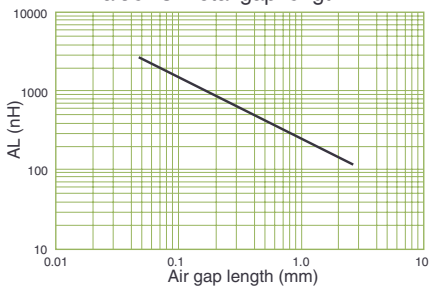

DC Pre-magnetization characteristics

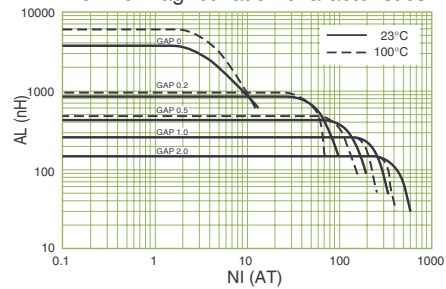

Core loss vs. Flux density f=100kHz

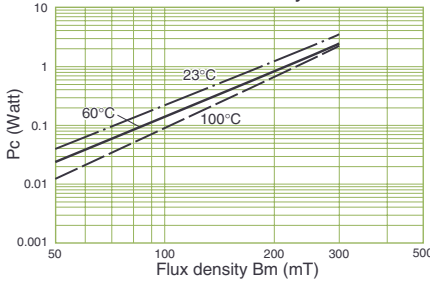

Core loss vs. Frequency Bm:200 (mT)

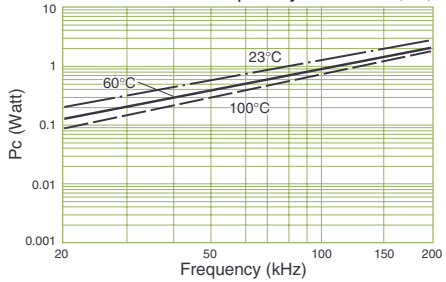

- All specifications in this catalog and production status of products are subject to change without notice. Prior to the purchase, please contact NEC TOKIN for updated product data.
- Please request for a specification sheet for detailed product data prior to the purchase.
- Before using the product in this catalog, please read "Precautions" and other safety precautions listed in the printed version catalog.

FEER 42A

AL*	Core constant C_p	Effective cross-sectional area A_e	Effective magnetic path length l_e	Effective volume V_e	Cross-sectional center leg area A_{cp}	Cross-sectional winding area of core A_{cw}	Weight
(nH)	(mm ⁻¹)	(mm ²)	(mm)	(mm ³)	(mm ²)	(mm ²)	(g/set)
5700±25%	0.44	232.5	101.4	23572	235.1	228.8	118.0

*1kHz 1mA ø0.7 100T(Air Gap 0)

Shape and Dimensions

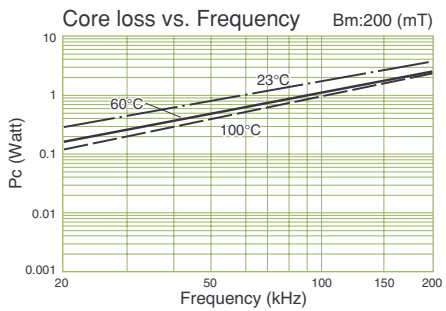
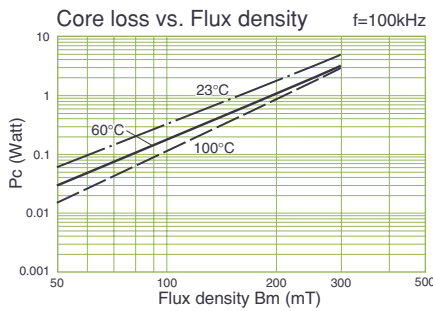
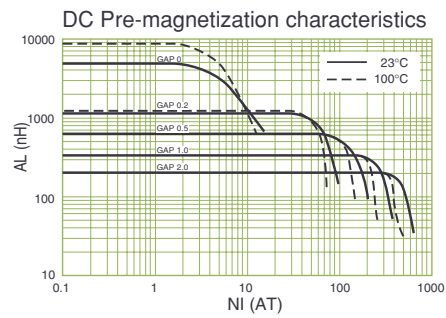
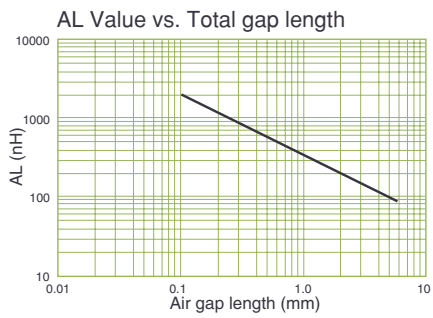
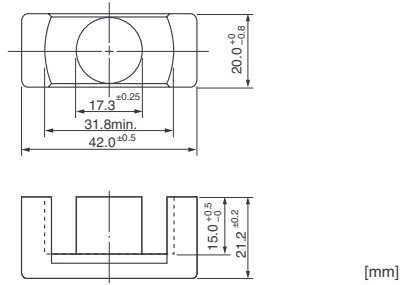

- All specifications in this catalog and production status of products are subject to change without notice. Prior to the purchase, please contact NEC TOKIN for updated product data.
- Please request for a specification sheet for detailed product data prior to the purchase.
- Before using the product in this catalog, please read "Precautions" and other safety precautions listed in the printed version catalog.

FEER 44

AL* (nH)	Core constant C_i (mm ⁻¹)	Effective cross-sectional area A_e (mm ²)	Effective magnetic path length l_e (mm)	Effective volume V_e (mm ³)	Cross-sectional center leg area A_{cp} (mm ²)	Cross-sectional winding area of core A_{cw} (mm ²)	Weight (g/set)
4000±25%	0.63	172.0	108.7	18707	172.0	306.7	88.6

*1kH 1mA ø0.7 100T(Air Gap 0)

Shape and Dimensions

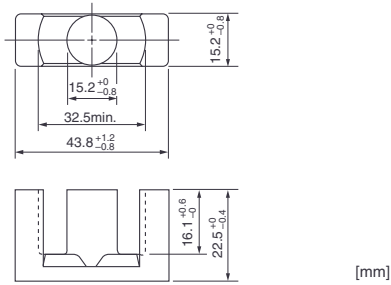

AL Value vs. Total gap length

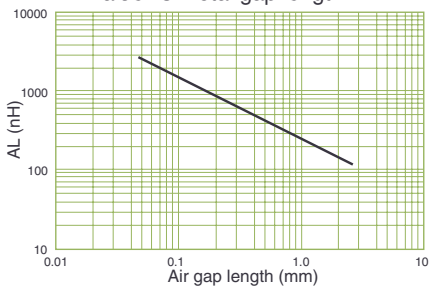

DC Pre-magnetization characteristics

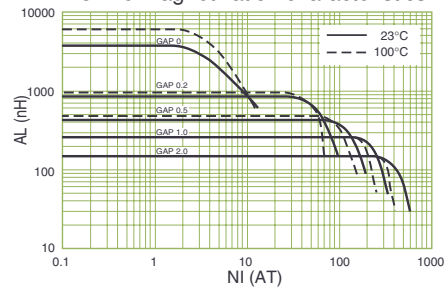

Core loss vs. Flux density $f=100\text{kHz}$

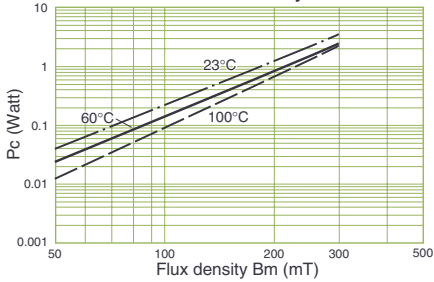

Core loss vs. Frequency $B_m:200\text{ (mT)}$

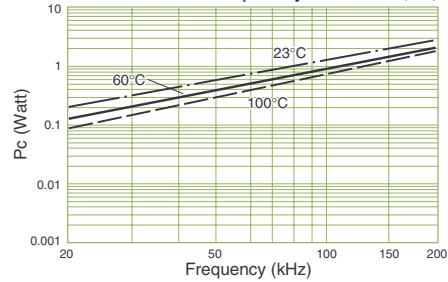

- All specifications in this catalog and production status of products are subject to change without notice. Prior to the purchase, please contact NEC TOKIN for updated product data.
- Please request for a specification sheet for detailed product data prior to the purchase.
- Before using the product in this catalog, please read "Precautions" and other safety precautions listed in the printed version catalog.

FPQ 2016

AL* (nH)	Core constant C_1 (mm ⁻¹)	Effective cross-sectional area A_e (mm ²)	Effective magnetic path length ℓ_e (mm)	Effective volume V_e (mm ³)	Cross-sectional center leg area A_{cp} (mm ²)	Cross-sectional winding area of core A_{cw} (mm ²)	Weight (g/set)
3800±25%	0.61	62	37.4	2310	61	47.4	13

*1kH 1mA ø0.4 100T(Air Gap 0)

Shape and Dimensions

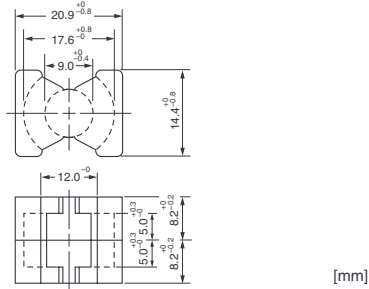

AL Value vs. Total gap length

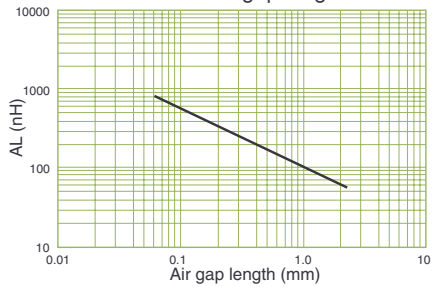

DC Pre-magnetization characteristics

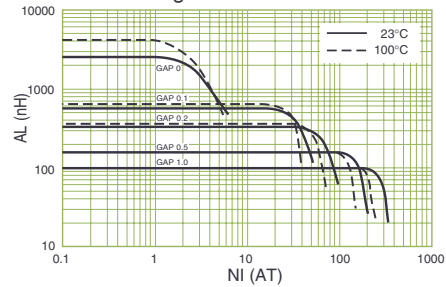

Core loss vs. Flux density f=100kHz

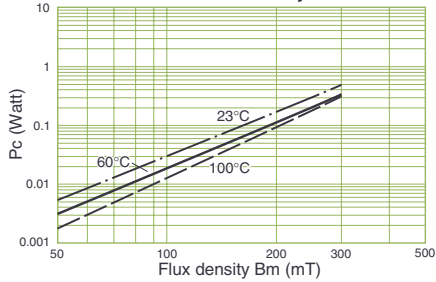

Core loss vs. Frequency Bm:200 (mT)

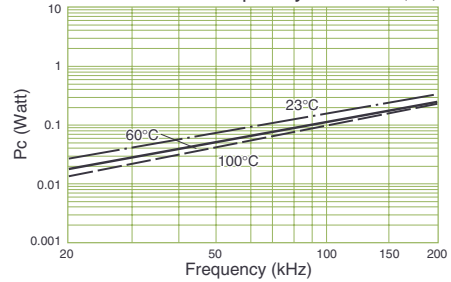

- All specifications in this catalog and production status of products are subject to change without notice. Prior to the purchase, please contact NEC TOKIN for updated product data.
- Please request for a specification sheet for detailed product data prior to the purchase.
- Before using the product in this catalog, please read "Precautions" and other safety precautions listed in the printed version catalog.

FPQ 2020

AL* (nH)	Core constant C_1 (mm ⁻¹)	Effective cross-sectional area Ae (mm ²)	Effective magnetic path length l_e (mm)	Effective volume Ve (mm ³)	Cross-sectional center leg area Acp (mm ²)	Cross-sectional winding area of core Acw (mm ²)	Weight (g/set)
3150±25%	0.74	62	45.4	2790	61	65.8	15

*1kHz 1mA ø0.4 100T(Air Gap 0)

Shape and Dimensions

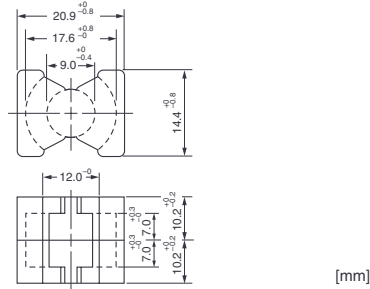

AL Value vs. Total gap length

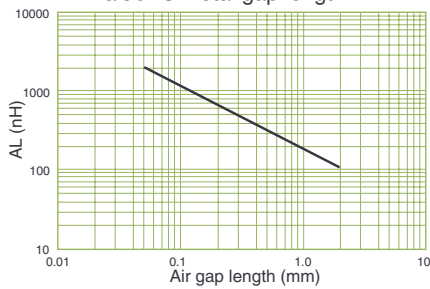

DC Pre-magnetization characteristics

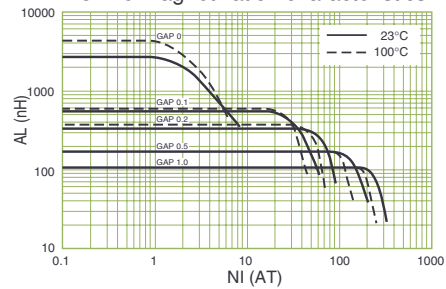

Core loss vs. Flux density f=100kHz

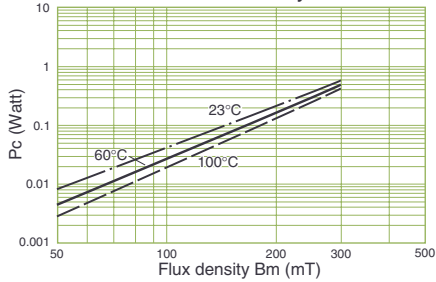

Core loss vs. Frequency Bm:200 (mT)

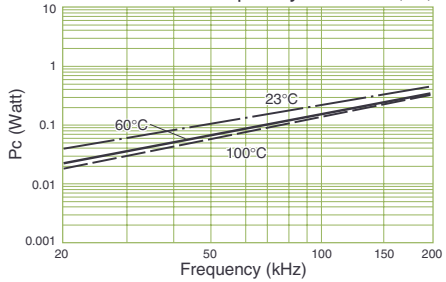

- All specifications in this catalog and production status of products are subject to change without notice. Prior to the purchase, please contact NEC TOKIN for updated product data.
- Please request for a specification sheet for detailed product data prior to the purchase.
- Before using the product in this catalog, please read "Precautions" and other safety precautions listed in the printed version catalog.

FPQ 2620

AL*	Core constant C_p	Effective cross-sectional area A_e	Effective magnetic path length ℓ_e	Effective volume V_e	Cross-sectional center leg area A_{cp}	Cross-sectional winding area of core A_{cw}	Weight
(nH)	(mm ⁻¹)	(mm ²)	(mm)	(mm ³)	(mm ²)	(mm ²)	(g/set)
6000±25%	0.39	119	46.3	5490	113	64.4	31

*1kH 1mA ø0.5 100T(Air Gap 0)

Shape and Dimensions

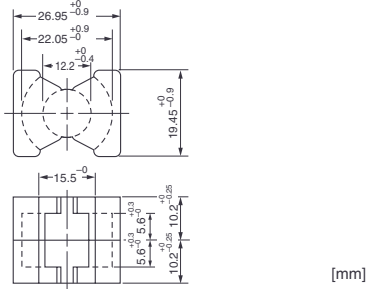

AL Value vs. Total gap length

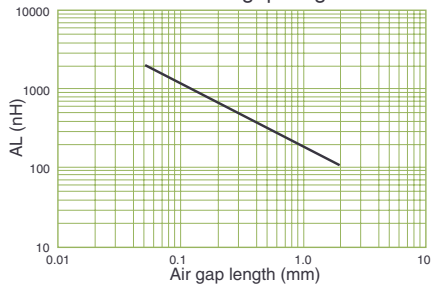

DC Pre-magnetization characteristics

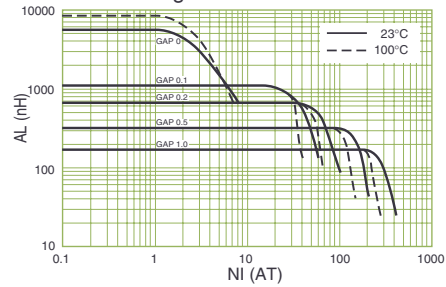

Core loss vs. Flux density f=100kHz

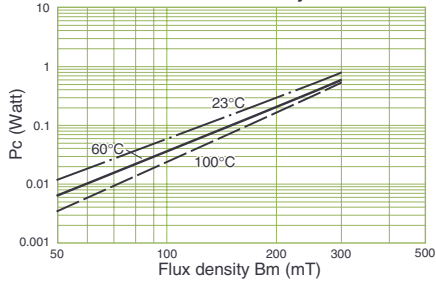

Core loss vs. Frequency Bm:200 (mT)

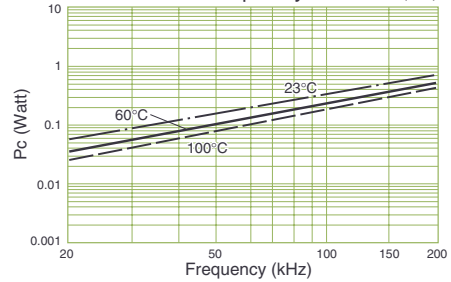

- All specifications in this catalog and production status of products are subject to change without notice. Prior to the purchase, please contact NEC TOKIN for updated product data.
- Please request for a specification sheet for detailed product data prior to the purchase.
- Before using the product in this catalog, please read "Precautions" and other safety precautions listed in the printed version catalog.

FPQ 2625

AL* (nH)	Core constant C_1 (mm ⁻¹)	Effective cross-sectional area A_e (mm ²)	Effective magnetic path length l_e (mm)	Effective volume V_e (mm ³)	Cross-sectional center leg area A_{cp} (mm ²)	Cross-sectional winding area of core A_{cw} (mm ²)	Weight (g/set)
5000±25%	0.47	118	55.5	6530	113	84.5	36

*1kHz 1mA ø0.5 100T(Air Gap 0)

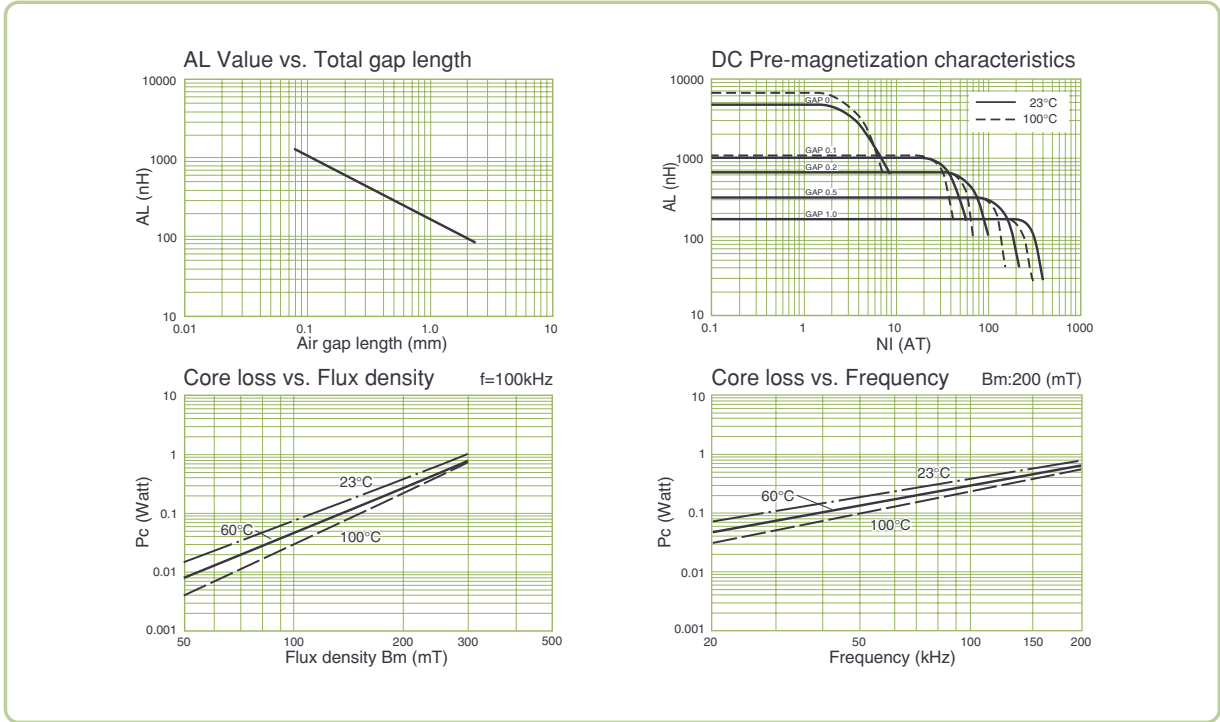
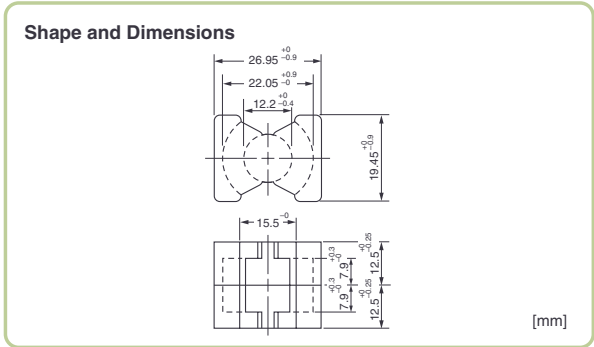

- All specifications in this catalog and production status of products are subject to change without notice. Prior to the purchase, please contact NEC TOKIN for updated product data.
- Please request for a specification sheet for detailed product data prior to the purchase.
- Before using the product in this catalog, please read "Precautions" and other safety precautions listed in the printed version catalog.

FPQ 3220

AL*	Core constant C_p	Effective cross-sectional area A_e	Effective magnetic path length ℓ_e	Effective volume V_e	Cross-sectional center leg area A_{cp}	Cross-sectional winding area of core A_{cw}	Weight
(nH)	(mm ⁻¹)	(mm ²)	(mm)	(mm ³)	(mm ²)	(mm ²)	(g/set)
7310±25%	0.33	170	55.5	9420	142	80.8	42

*1kH 1mA ø0.6 100T(Air Gap 0)

Shape and Dimensions

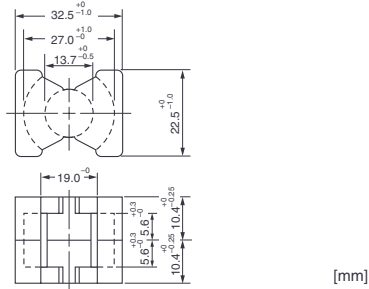

AL Value vs. Total gap length

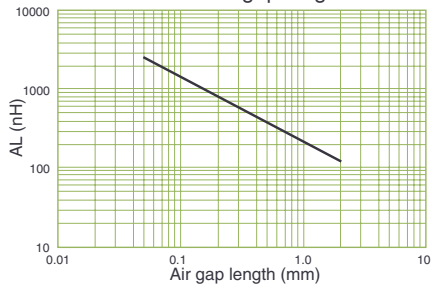

DC Pre-magnetization characteristics

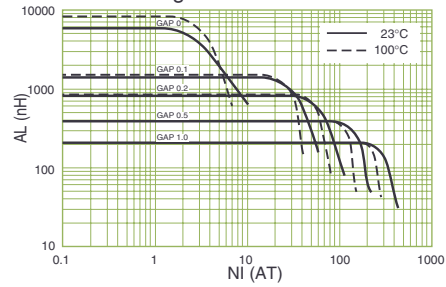

Core loss vs. Flux density f=100kHz

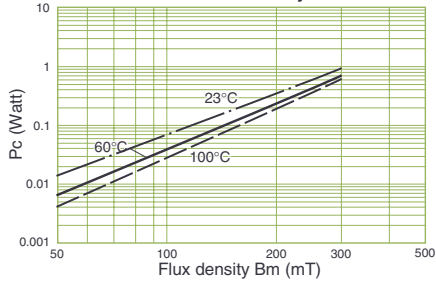

Core loss vs. Frequency Bm:200 (mT)

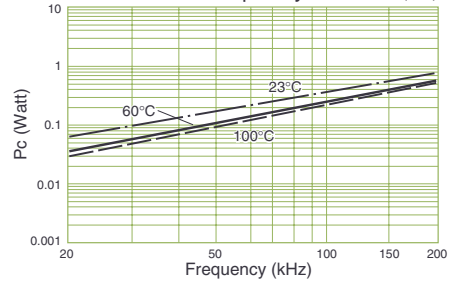

- All specifications in this catalog and production status of products are subject to change without notice. Prior to the purchase, please contact NEC TOKIN for updated product data.
- Please request for a specification sheet for detailed product data prior to the purchase.
- Before using the product in this catalog, please read "Precautions" and other safety precautions listed in the printed version catalog.

FPQ 3230

AL* (nH)	Core constant C_1 (mm ⁻¹)	Effective cross-sectional area A_e (mm ²)	Effective magnetic path length l_e (mm)	Effective volume V_e (mm ³)	Cross-sectional center leg area A_{cp} (mm ²)	Cross-sectional winding area of core A_{cw} (mm ²)	Weight (g/set)
5150±25%	0.46	161	74.6	11970	142	149.6	55

*1kHz 1mA ø0.6 100T(Air Gap 0)

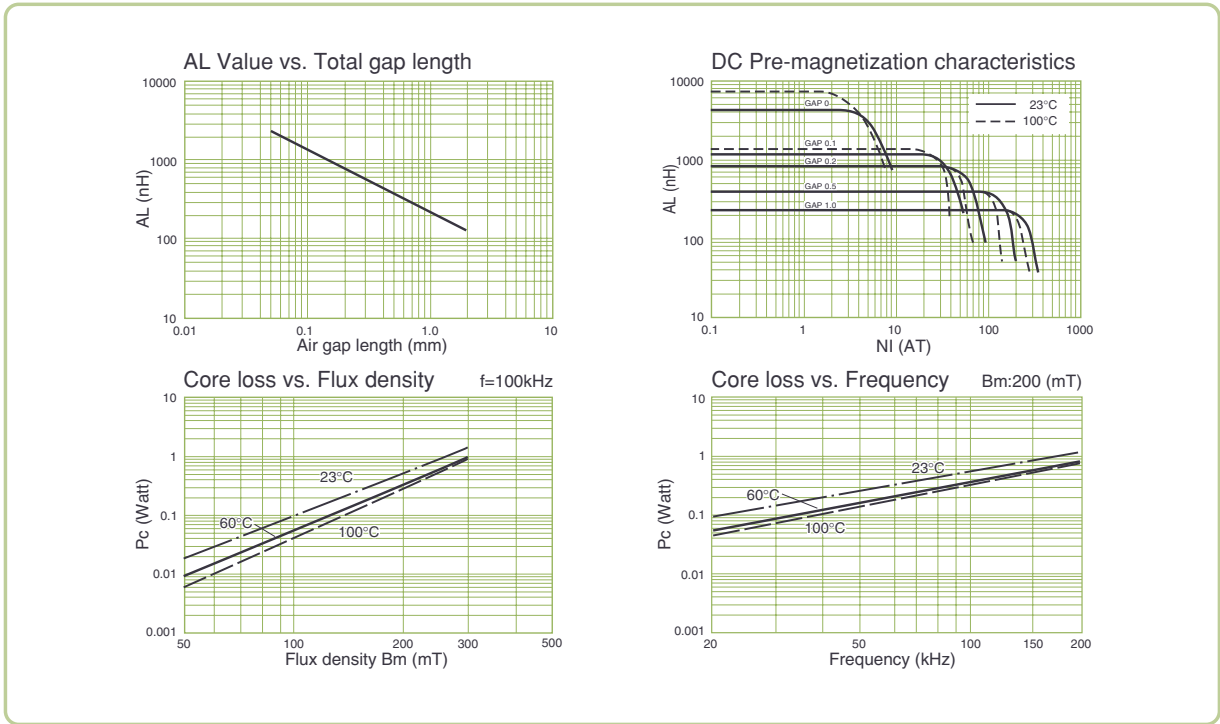
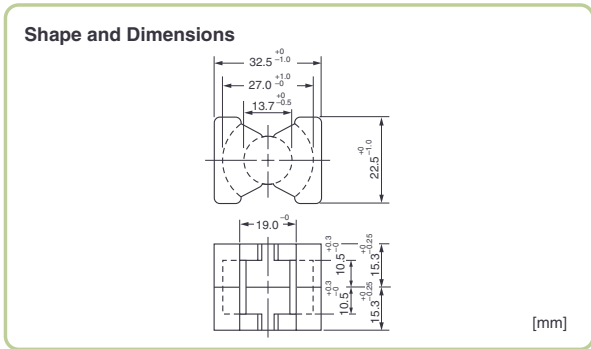

- All specifications in this catalog and production status of products are subject to change without notice. Prior to the purchase, please contact NEC TOKIN for updated product data.
- Please request for a specification sheet for detailed product data prior to the purchase.
- Before using the product in this catalog, please read "Precautions" and other safety precautions listed in the printed version catalog.

FPQ 3535

AL* (nH)	Core constant C_p (mm ⁻¹)	Effective cross-sectional area A_e (mm ²)	Effective magnetic path length ℓ_e (mm)	Effective volume V_e (mm ³)	Cross-sectional center leg area A_{cp} (mm ²)	Cross-sectional winding area of core A_{cw} (mm ²)	Weight (g/set)
4900±25%	0.45	196	87.9	17260	162	220.6	73

*1kHz 1mA ø0.7 100T(Air Gap 0)

Shape and Dimensions

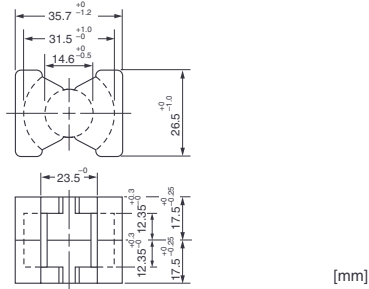

AL Value vs. Total gap length

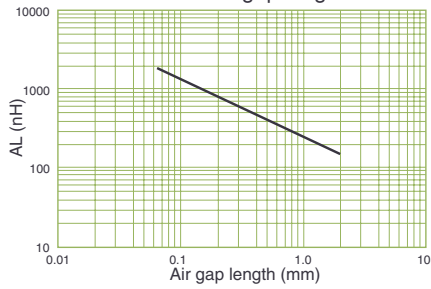

DC Pre-magnetization characteristics

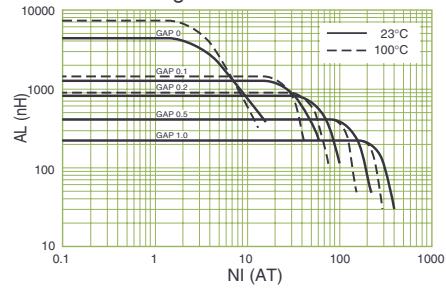

Core loss vs. Flux density f=100kHz

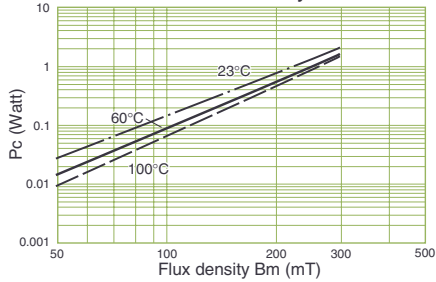

Core loss vs. Frequency Bm:200 (mT)

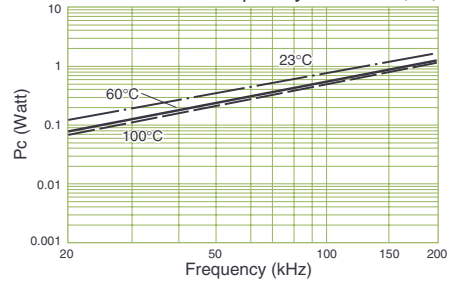

- All specifications in this catalog and production status of products are subject to change without notice. Prior to the purchase, please contact NEC TOKIN for updated product data.
- Please request for a specification sheet for detailed product data prior to the purchase.
- Before using the product in this catalog, please read "Precautions" and other safety precautions listed in the printed version catalog.

FPQ 4040

AL* (nH)	Core constant C _i (mm ⁻¹)	Effective cross-sectional area A _e (mm ²)	Effective magnetic path length l _e (mm)	Effective volume V _e (mm ³)	Cross-sectional center leg area A _{cp} (mm ²)	Cross-sectional winding area of core A _{cw} (mm ²)	Weight (g/set)
4700±25%	0.51	201	101.9	20450	174	326	95

*1kHz 1mA ø0.7 100T(Air Gap 0)

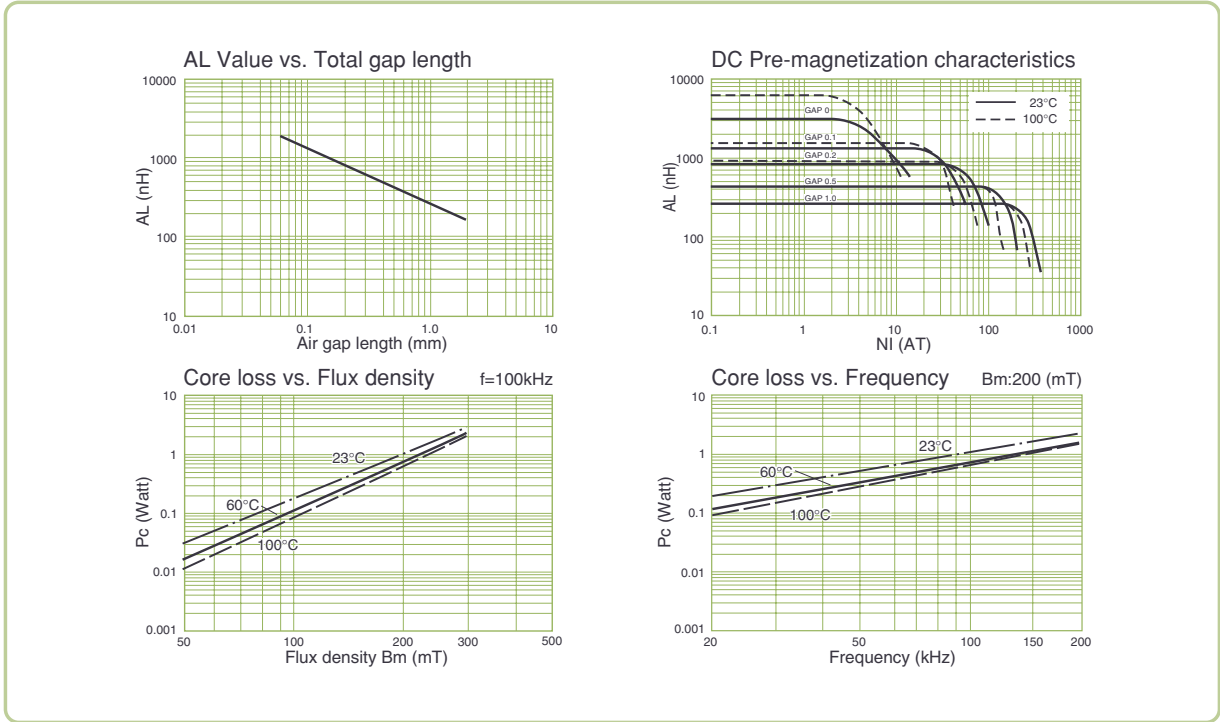
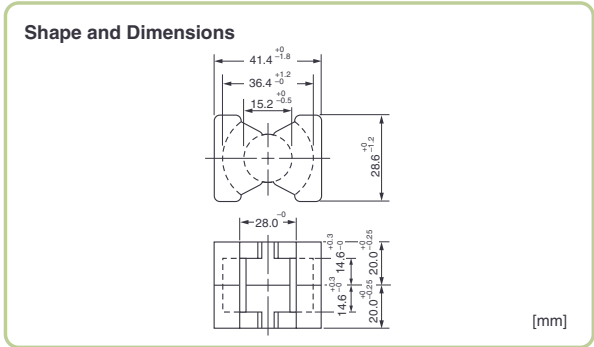

- All specifications in this catalog and production status of products are subject to change without notice. Prior to the purchase, please contact NEC TOKIN for updated product data.
- Please request for a specification sheet for detailed product data prior to the purchase.
- Before using the product in this catalog, please read "Precautions" and other safety precautions listed in the printed version catalog.

FQK 1623

AL* (nH)	Core constant C_p (mm ⁻¹)	Effective cross-sectional area A_e (mm ²)	Effective magnetic path length ℓ_e (mm)	Effective volume V_e (mm ³)	Cross-sectional center leg area A_{cp} (mm ²)	Cross-sectional winding area of core A_{cw} (mm ²)	Weight (g/set)
1700±25%	1.41	31.3	44.1	1377	24.6	31.9	9.6

*1kH 1mA ø0.4 100T(Air Gap 0)

Shape and Dimensions

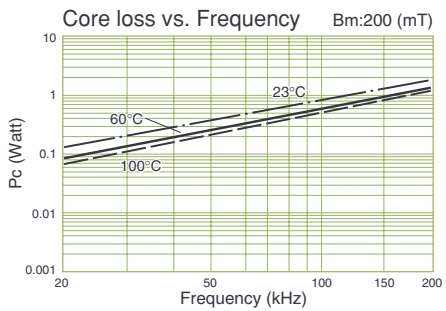
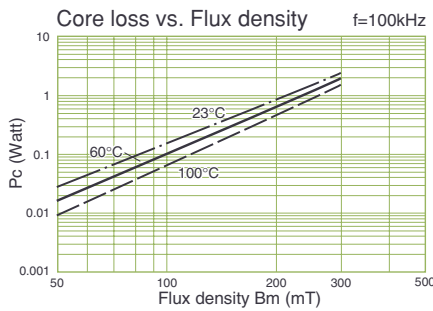
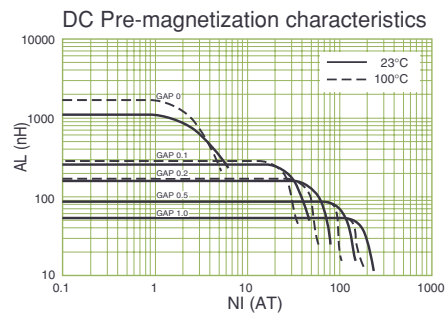
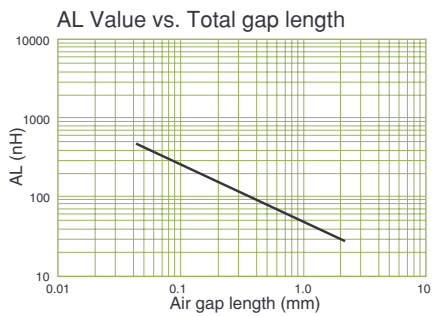
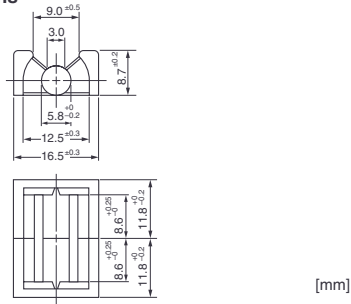

- All specifications in this catalog and production status of products are subject to change without notice. Prior to the purchase, please contact NEC TOKIN for updated product data.
- Please request for a specification sheet for detailed product data prior to the purchase.
- Before using the product in this catalog, please read "Precautions" and other safety precautions listed in the printed version catalog.

FQK 2522

AL* (nH)	Core constant C_i (mm ⁻¹)	Effective cross-sectional area A_e (mm ²)	Effective magnetic path length l_e (mm)	Effective volume V_e (mm ³)	Cross-sectional center leg area A_{cp} (mm ²)	Cross-sectional winding area of core A_{cw} (mm ²)	Weight (g/set)
3200±25%	0.72	67.9	49.0	3327	58.1	48	21.0

*1kHz 1mA ø0.6 100T(Air Gap 0)

Shape and Dimensions

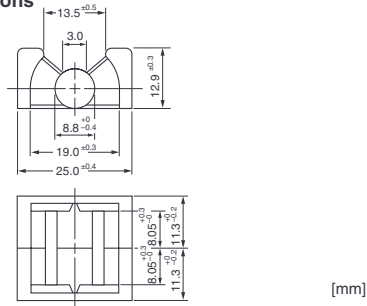

AL Value vs. Total gap length

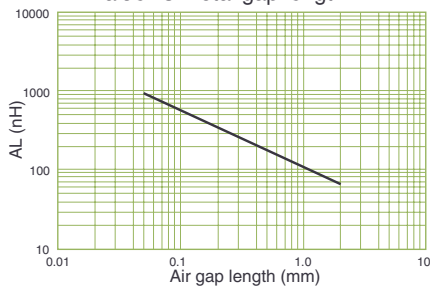

DC Pre-magnetization characteristics

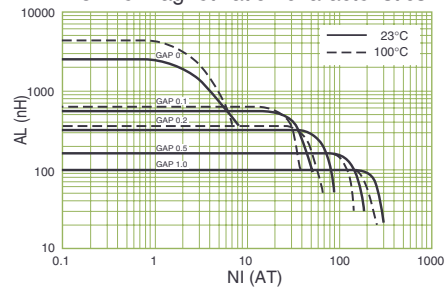

Core loss vs. Flux density $f=100\text{kHz}$

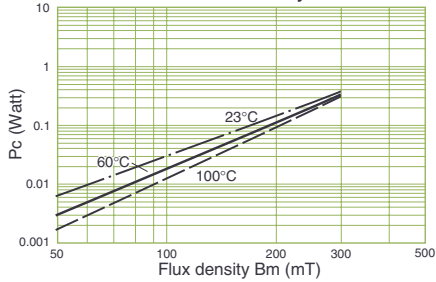

Core loss vs. Frequency $B_m:200\text{ mT}$

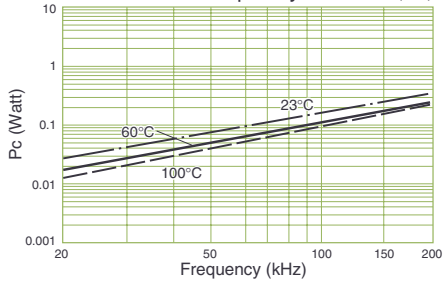

- All specifications in this catalog and production status of products are subject to change without notice. Prior to the purchase, please contact NEC TOKIN for updated product data.
- Please request for a specification sheet for detailed product data prior to the purchase.
- Before using the product in this catalog, please read "Precautions" and other safety precautions listed in the printed version catalog.

FQK 2532

AL* (nH)	Core constant C_p (mm ⁻¹)	Effective cross-sectional area A_e (mm ²)	Effective magnetic path length l_e (mm)	Effective volume V_e (mm ³)	Cross-sectional center leg area A_{cp} (mm ²)	Cross-sectional winding area of core A_{cw} (mm ²)	Weight (g/set)
2500±25%	0.91	70.3	64.0	4498	58.1	73.8	30.0

*1kH 1mA ø0.6 100T(Air Gap 0)

Shape and Dimensions

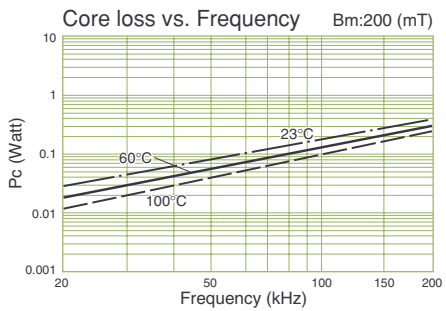
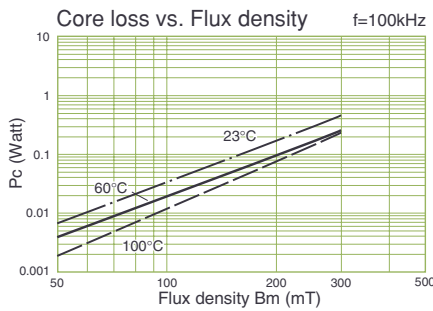
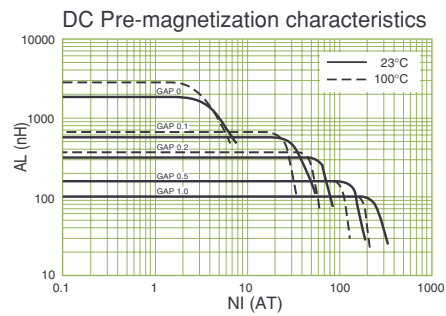
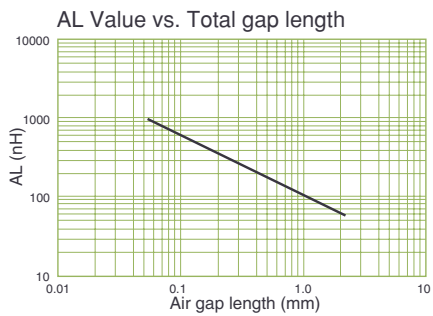
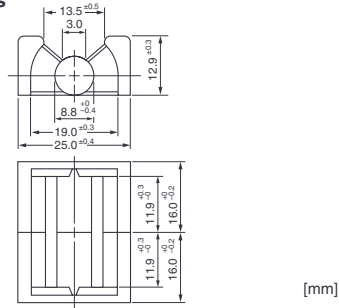

- All specifications in this catalog and production status of products are subject to change without notice. Prior to the purchase, please contact NEC TOKIN for updated product data.
- Please request for a specification sheet for detailed product data prior to the purchase.
- Before using the product in this catalog, please read "Precautions" and other safety precautions listed in the printed version catalog.

Precautions



- The names of the products and the specifications in this catalog are subject to change without notice for the sake of improvement. The manufacturer also reserves the right to discontinue any of these products. At the time of delivery, please ask for specifications sheets to check the contents in order to use the products properly and safely.
- Descriptions in this catalog regarding product characteristics and quality are based solely on discrete components. When using these components, be sure to check the specifications with the component in question mounted on the products.
- The manufacturer's warranty will not cover any disadvantage or damage caused by improper use of the products that deviates from the characteristics, specifications, or conditions for use described in this catalog.
- The products in this catalog are intended for use in ordinary electronic products. If any of these products are to be used in special applications requiring extremely high reliability, such as in aviation equipment and nuclear power controllers where product defects might pose a safety risk, please consult your NEC TOKIN sales representatives.
- Though the manufacturer has taken all possible precautions to ensure the quality and reliability of its products, improper use of products may result in bodily injury, fire, or similar accident. If you have any questions regarding the use of the products in question, please consult your NEC TOKIN sales representatives.
- Please be advised that the manufacturer accepts no responsibility for any infraction by users of the manufacturer's products on third party patents or industrial copyrights. The manufacturer is responsible only when such infractions are attributable to the structural design of the product and its manufacturing process.
- Export Control
For customers outside Japan
NEC-TOKIN products should not be used or sold for use in the development, production, stockpiling or utilization of any conventional weapons or mass-destructive weapons(nuclear weapons, chemical or biological weapons, or missiles), or any other weapons.
For customers in Japan
For products which are controlled items subject to the 'Foreign Exchange and Foreign Trade Law' of Japan, the export license specified by the law is required for export.
- This catalog is current as of December 2009.



- All specifications in this catalog and production status of products are subject to change without notice. Prior to the purchase, please contact NEC TOKIN for updated product data.
- Please request for a specification sheet for detailed product data prior to the purchase.
- Before using the product in this catalog, please read "Precautions" and other safety precautions listed in the printed version catalog.